

Charged Lepton Flavor Violation in the τ Sector

Swagato Banerjee



UNIVERSITY OF
LOUISVILLE



On behalf of Belle and Belle II collaborations



Join us at
INTERSECTIONS
~~May 30 - June 5, 2022~~

Lake Buena Vista, Fla

August 29-
September 4



Charged Lepton flavor violation (LFV) in τ decays

LFV is not forbidden by any continuous symmetry
 \Rightarrow most new physics (NP) models naturally include LFV

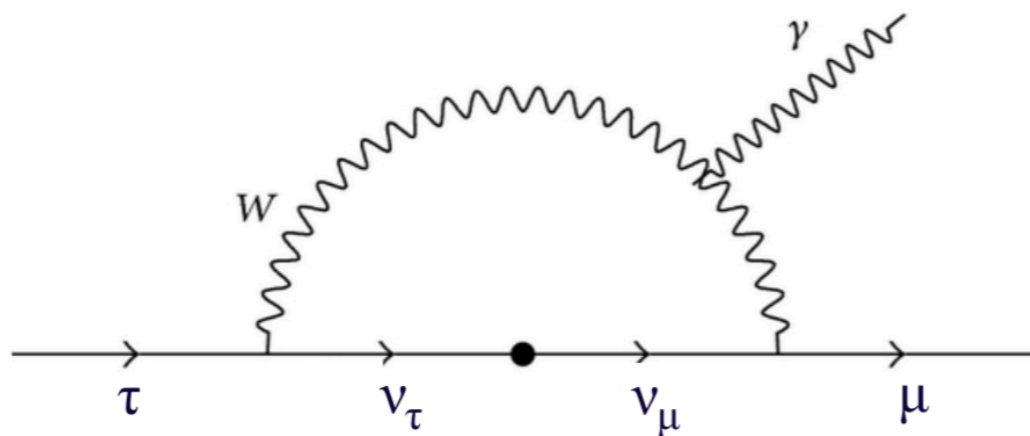

$$\mathcal{B}(\tau^\pm \rightarrow \mu^\pm \gamma) \quad \text{Lee \& Shrock: Phys.Rev.D 16 (1977) 1444}$$

$$= \frac{3\alpha}{128\pi} \left(\frac{\Delta m_{23}^2}{M_W^2} \right)^2 \sin^2 2\theta_{\text{mix}} \mathcal{B}(\tau \rightarrow \mu \bar{\nu}_\mu \nu_\tau)$$

With $\Delta \sim 10^{-3} \text{ eV}^2$, $M_W \sim \mathcal{O}(10^{11}) \text{ eV}$
 $\approx \mathcal{O}(10^{-54})$ ($\theta_{\text{mix}} : \text{max}$)

many orders below experimental sensitivity!

Any observation of LFV \Rightarrow unambiguous signature of NP

LFV in tau sector is complementary to muon sector in NP parameter space:
 current limit on $\mathcal{B}(\mu \rightarrow e\gamma) \sim 10^{-13}$ does not forbid $\mathcal{B}(\tau \rightarrow \ell\gamma) \sim 10^{-8}$

Leptonic MFV:	$\text{BR}(\mu \rightarrow e\gamma) / \text{BR}(\tau \rightarrow \mu\gamma) \sim s_{13}^2 \sim 10^{-2}$
GUT models:	$\text{BR}(\mu \rightarrow e\gamma) / \text{BR}(\tau \rightarrow \mu\gamma) \sim V_{us} ^6 \sim 10^{-4}$

Vincenzo Cirigliano, Benjamin Grinstein, Gino Isidori, Mark B. Wise: [hep-ph/0507001](https://arxiv.org/abs/hep-ph/0507001) [hep-ph], [hep-ph/0608123](https://arxiv.org/abs/hep-ph/0608123) [hep-ph]
 R. Barbieri, L. Hall, A. Strumia: [hep-ph/9501334](https://arxiv.org/abs/hep-ph/9501334) [hep-ph]

New Physics expectations

● Mass dependent couplings enhance tau LFV w.r.t. lighter leptons

Low- and high-energy phenomenology of a doubly charged scalar
 A. Crivellin et. al.
 Phys. Rev. D 99, 035004
 (2019)

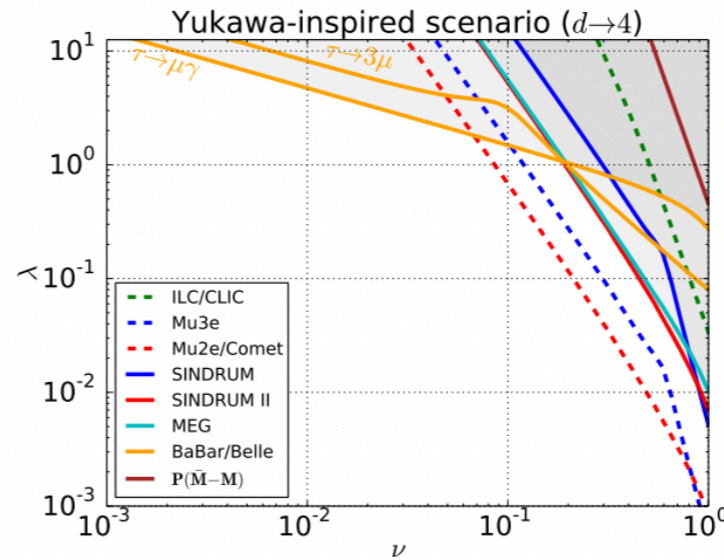
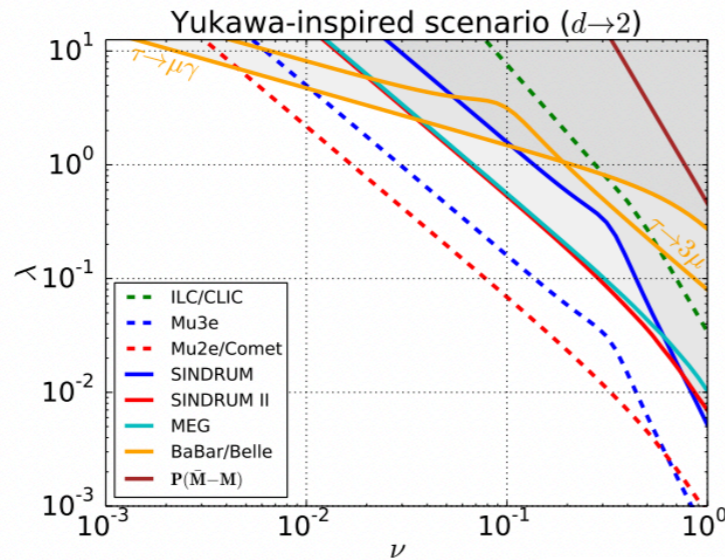

$$\lambda_{ab} \sim (y_a^l y_b^l)^{-1}$$

$$\lambda_{ab} = \lambda \begin{pmatrix} \pm 1 & \nu^2 & \nu^3 \\ \nu^2 & \nu^4 & \nu^5 \\ \nu^3 & \nu^5 & \nu^6 \end{pmatrix}$$

- Some models predict LFV up to existing experimental bounds
- eg. SUSY models: non-diagonal slepton mass matrix \Rightarrow LFV
- Normal (Inverted) hierarchy for slepton $\Rightarrow \tau \rightarrow \mu\gamma$ ($\tau \rightarrow e\gamma$)
- Neutrinoless 2 and 3 body τ decays have different sensitivity

	$\mathcal{B}(\tau \rightarrow l\gamma)$	$\mathcal{B}(\tau \rightarrow lll)$
SUSY SO(10) (NPB649(2003)189, PRD68(2003)033012)	10^{-8}	10^{-10}
SUSY Higgs (PLB549(2002)159, PLB566(2003)217)	10^{-10}	10^{-8}
Non-Universal Z' (PLB547(2002)252)	10^{-9}	10^{-8}
SM+Heavy Majorana ν_R (PRD66(2002)034008)	10^{-9}	10^{-10}

👉 Search for $\tau \rightarrow l\gamma/P^0$, $\tau \rightarrow lll$, $\tau \rightarrow lhh'$ decays ($l = e, \mu$; $h = \pi, K$)

New Physics illustrations

Tree level :

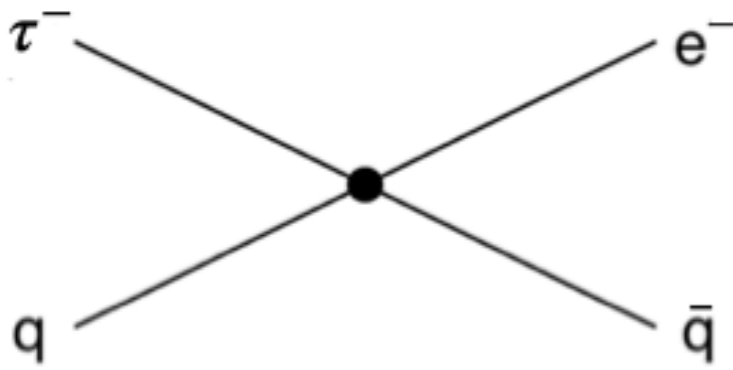

Compositeness

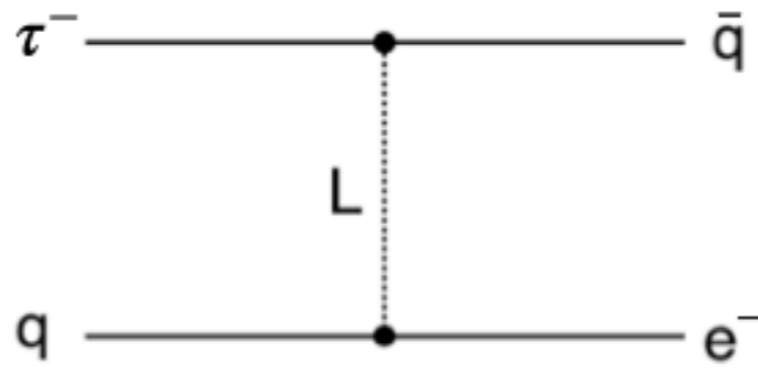

Leptoquarks

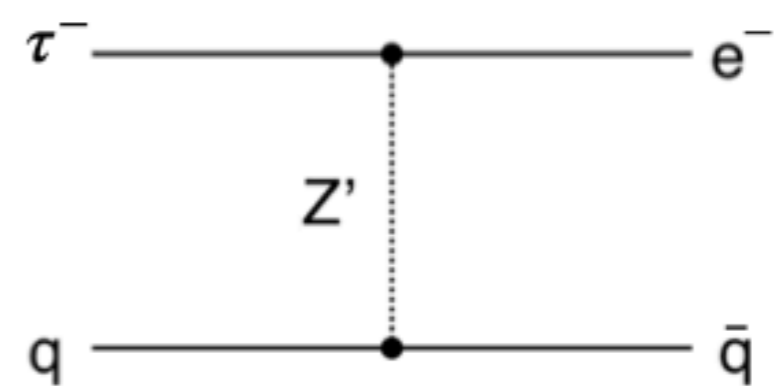

Heavy gauge bosons

Loop induced :

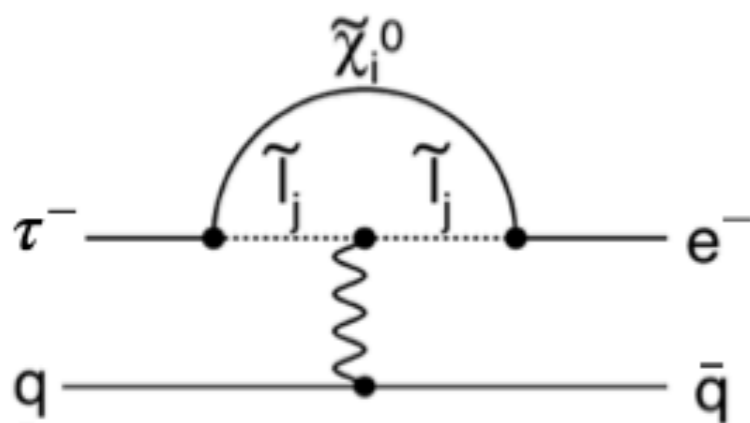

Supersymmetry

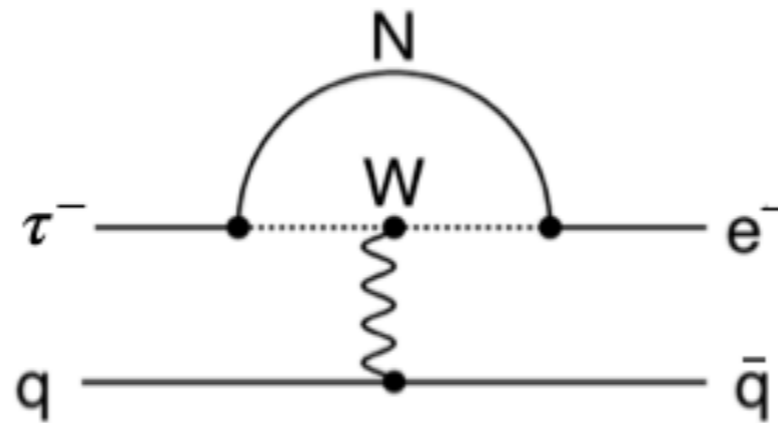

Heavy neutrinos

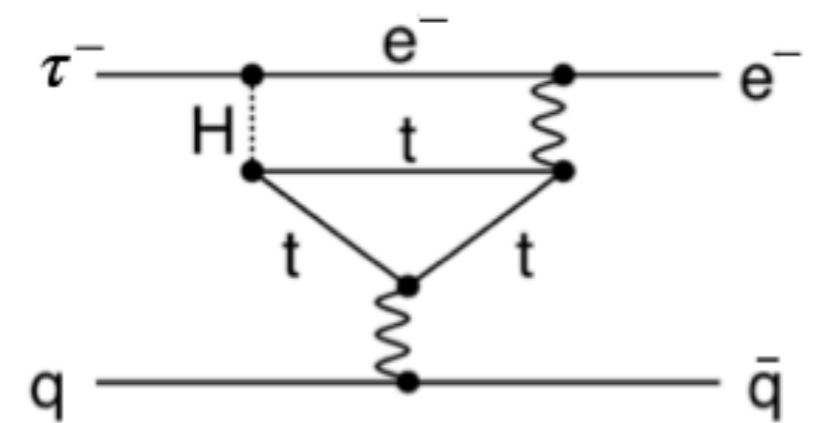

Extended Higgs models

Current and future experiments

Belle II at SuperKEKB

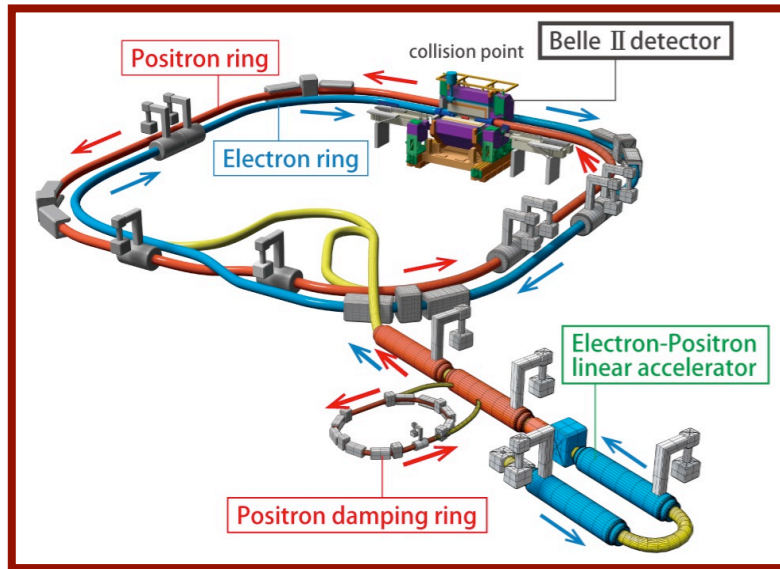

ATLAS, CMS, LHCb at LHC

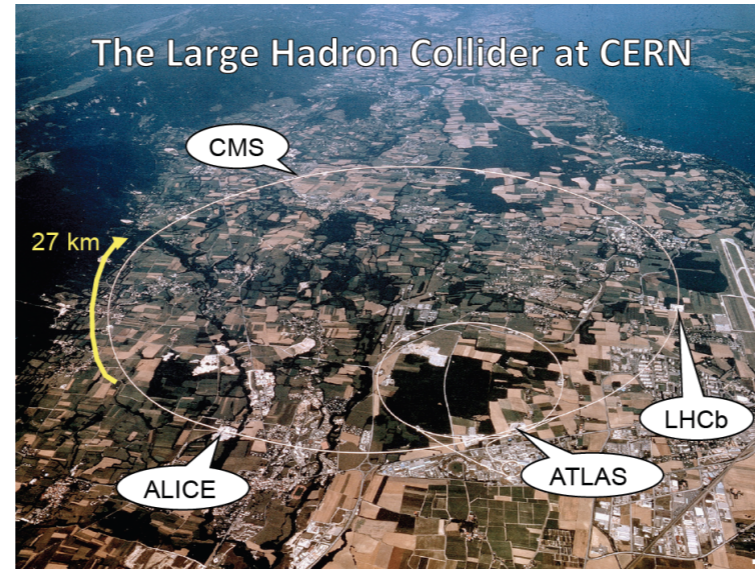

STCF proposal at China/Novosibirsk



EIC at Brookhaven

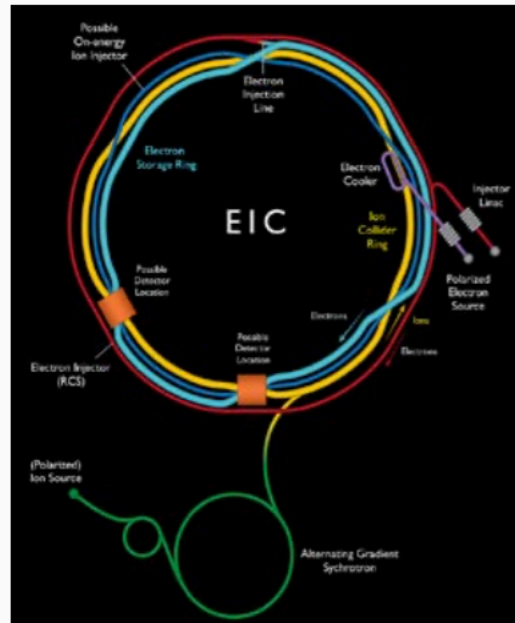

FCC-ee proposal – CERN

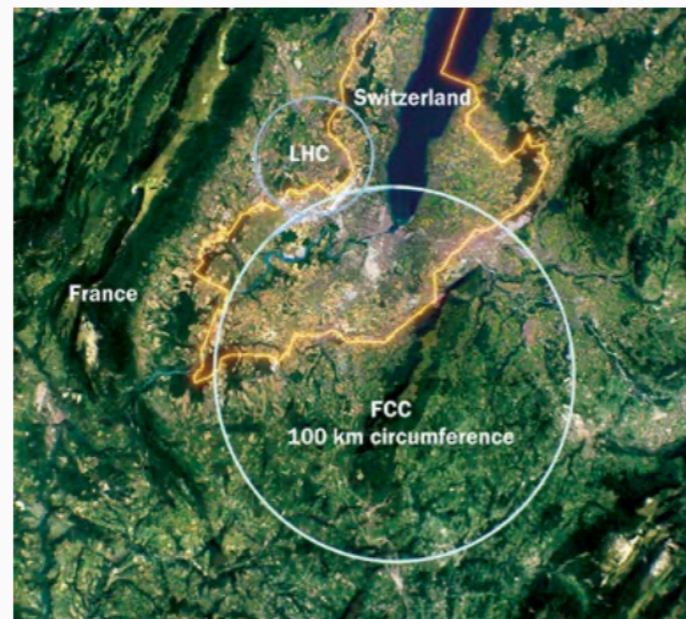

Tentative timeline

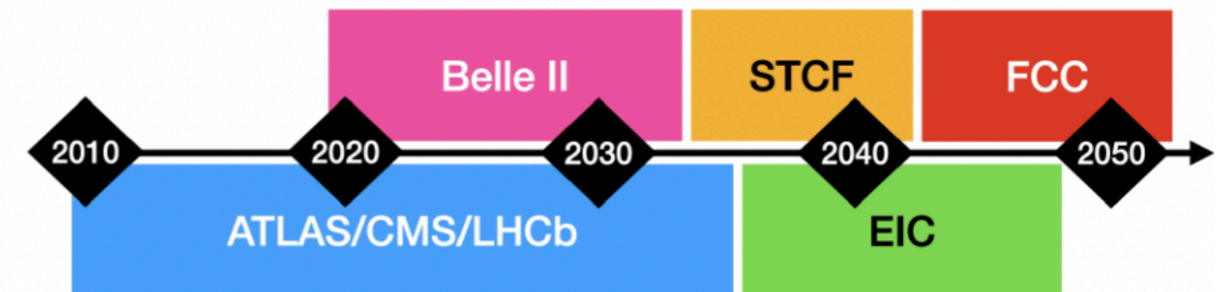

[e-Print: 2203.14919 \[hep-ph\]](https://arxiv.org/abs/2203.14919)

About fifty τ decay modes & many transitions with τ in the final state

- **Lepton flavor violation (charge conjugate modes implied)**
 - $\tau \rightarrow e/\mu \gamma$ (Belle II, STCF, FCC-ee)
 - $\tau \rightarrow e/\mu$ (scalar/pseudoscalar/vector mesons) (Belle II)
 - $\tau \rightarrow e e e$ (Belle II)
 - $\tau \rightarrow \mu \mu \mu$ (Belle II, ATLAS, CMS, LHCb, STCF, FCC-ee)
 - $\tau \rightarrow e \mu \mu, \mu e e$ (Belle II)
 - $\tau \rightarrow e/\mu h h$ (non-resonant final states with $h=\pi/K$) (Belle II, STCF)
 - $\tau \rightarrow e/\mu$ invisible (α) (Belle II)
 - $H \rightarrow e \tau, \mu \tau$ (ATLAS, CMS)
 - $Z(Z') \rightarrow e \tau, \mu \tau$ (ATLAS, CMS)
 - $e \rightarrow \tau$ transitions (EIC)
- **Lepton number violation**
 - $\tau^- \rightarrow e^+ h^- h^-$ (non-resonant final states with $h=\pi/K$) (Belle II)
 - $\tau^- \rightarrow \mu^+ h^- h^-$ (non-resonant final states with $h=\pi/K$) (Belle II)
- **Baryon number violation**
 - $\tau^- \rightarrow \Lambda \pi^-, \bar{\Lambda} \pi^-$ (Belle II)
 - $\tau^- \rightarrow \bar{p} \mu^+ \mu^-, p \mu^- \mu^-$ (Belle II, LHCb)

New

$\tau \rightarrow \ell \alpha$ at Belle II

- LFV decay: $\tau \rightarrow \ell \alpha$ (where $\ell = e$ or μ , and α is an invisible boson)
- α can enter from new physics models, eg. light axion like particles (ALP), Z' , etc.

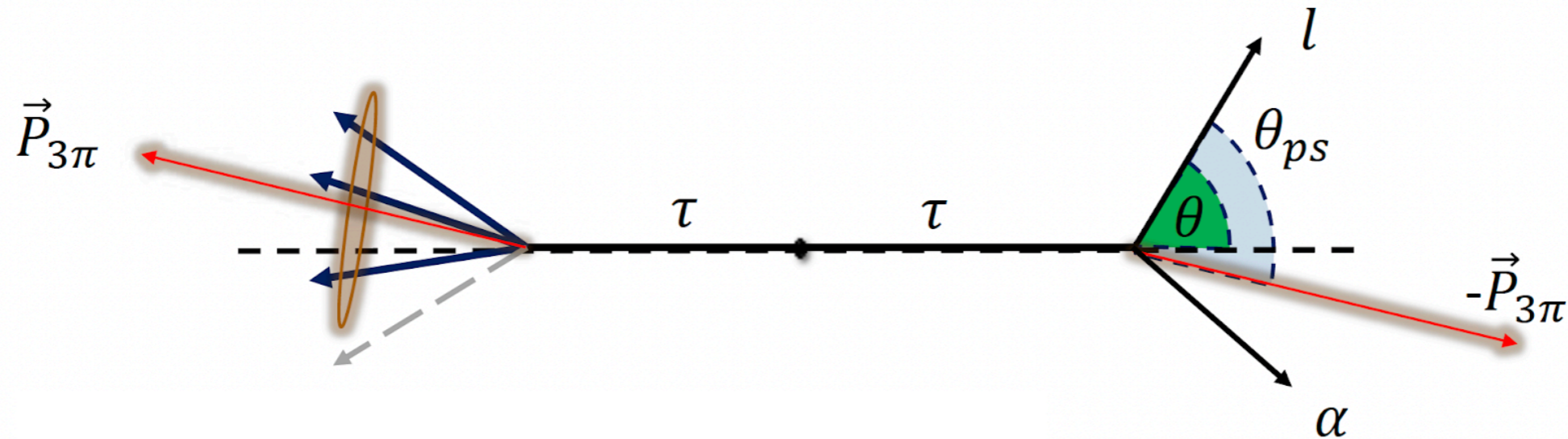

Signature of the signal process

2-body $\tau \rightarrow \ell \alpha$ decay will appear as a bump against the SM 3-body $\tau \rightarrow \ell \nu \bar{\nu}$ background in the p_ℓ distribution in the τ pseudo-rest frame:

$$\hat{p}_\tau \approx -\frac{\vec{P}_{tag}}{|\vec{P}_{tag}|}, \quad E_\tau \approx \sqrt{s}/2$$

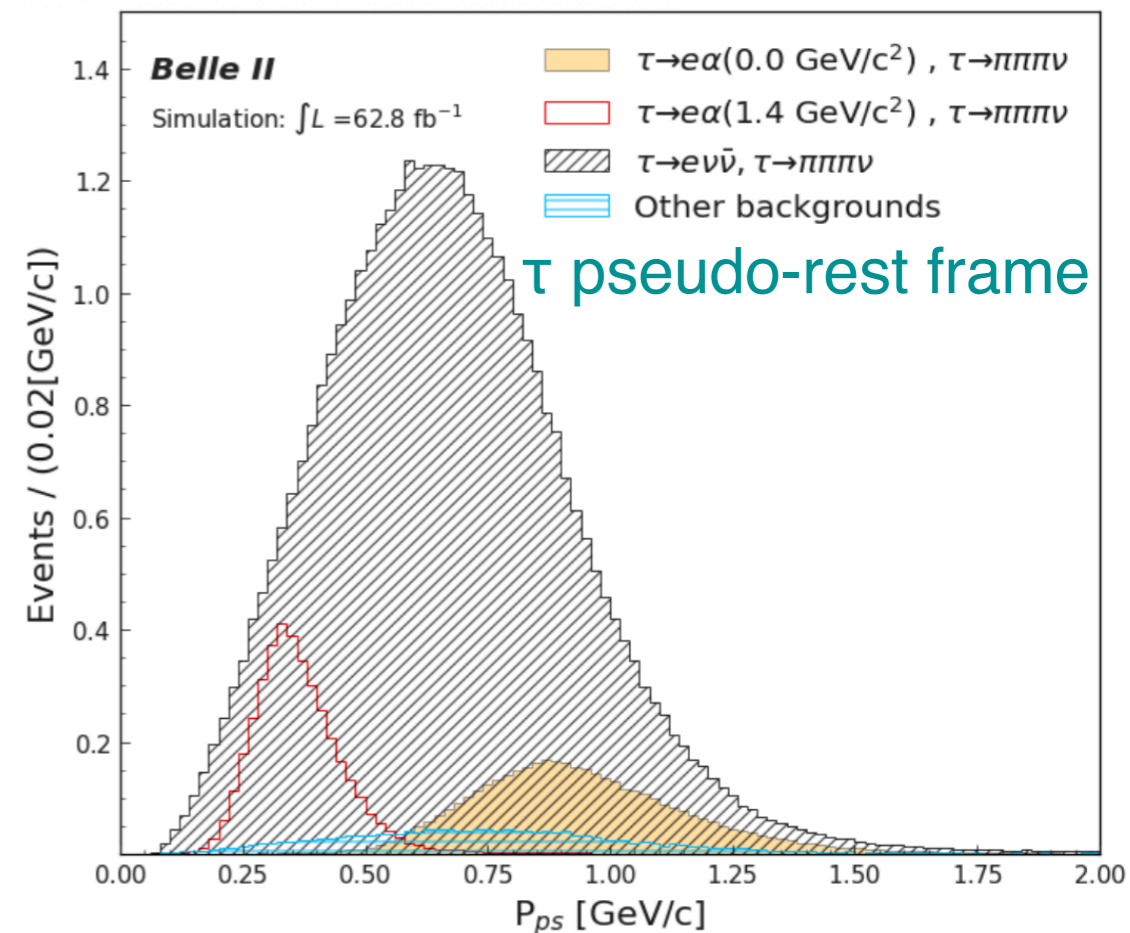

$\tau \rightarrow \ell \alpha$ at Belle II

Event reconstruction:

- Split event into hemispheres \perp to thrust axis (\hat{n}_T) which maximizes $\text{Thrust} = \max\left(\frac{\sum |\vec{p}_i| \cdot \hat{n}_T}{\sum |\vec{p}_i|}\right)$
- Require exactly 4 tracks: 1 in signal-side, 3 in tag-side
- Veto neutrals (π^0, γ) to suppress hadronic background.

Backgrounds reduced by cuts:

- $q\bar{q}, \ell^+\ell^-, \ell^+\ell^-\ell^+\ell^-, \ell^+\ell^-h^+h^-$ and $\tau^+\tau^-$ with misidentified signal (e.g. $\tau \rightarrow \pi\nu$)

Data-MC agreement in the discriminating variable: $x_\ell = 2E_\ell^{ps}/m_\tau$

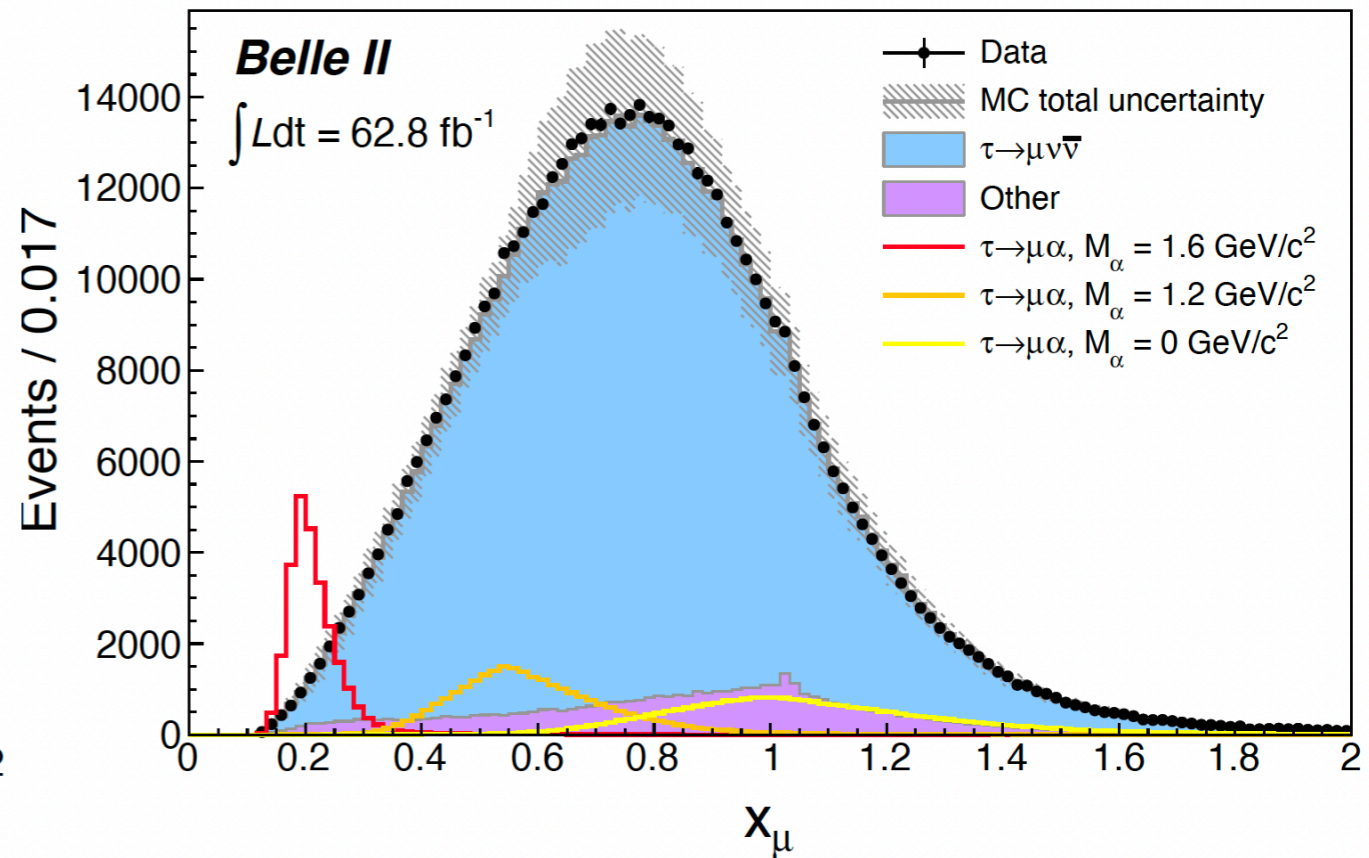
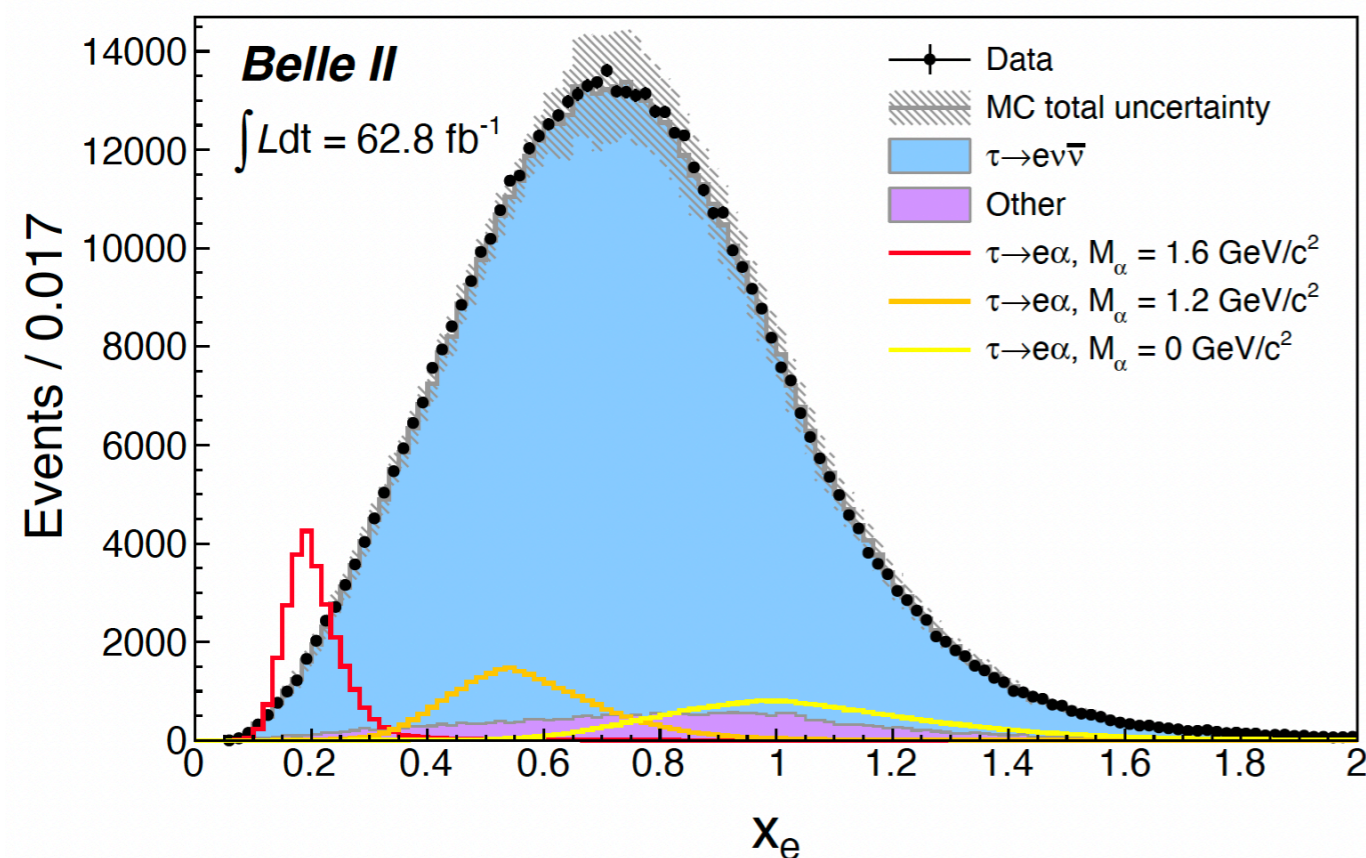
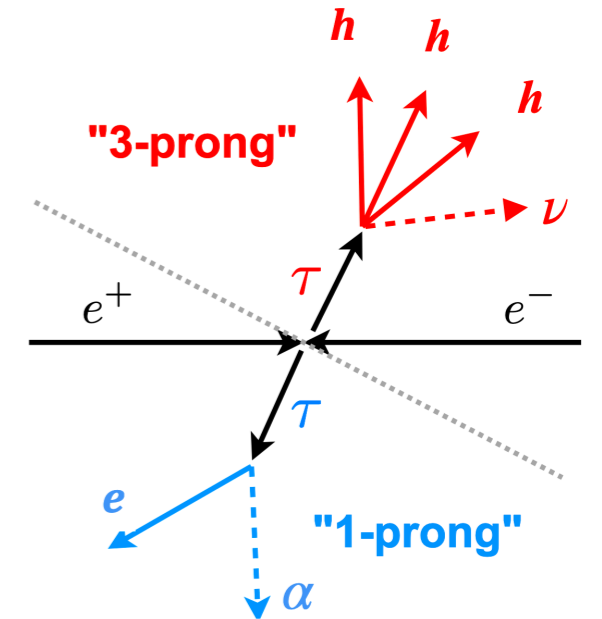

$\tau \rightarrow \ell \alpha$ at Belle II

95% C.L. upper limits from Belle II (ICHEP'2022)

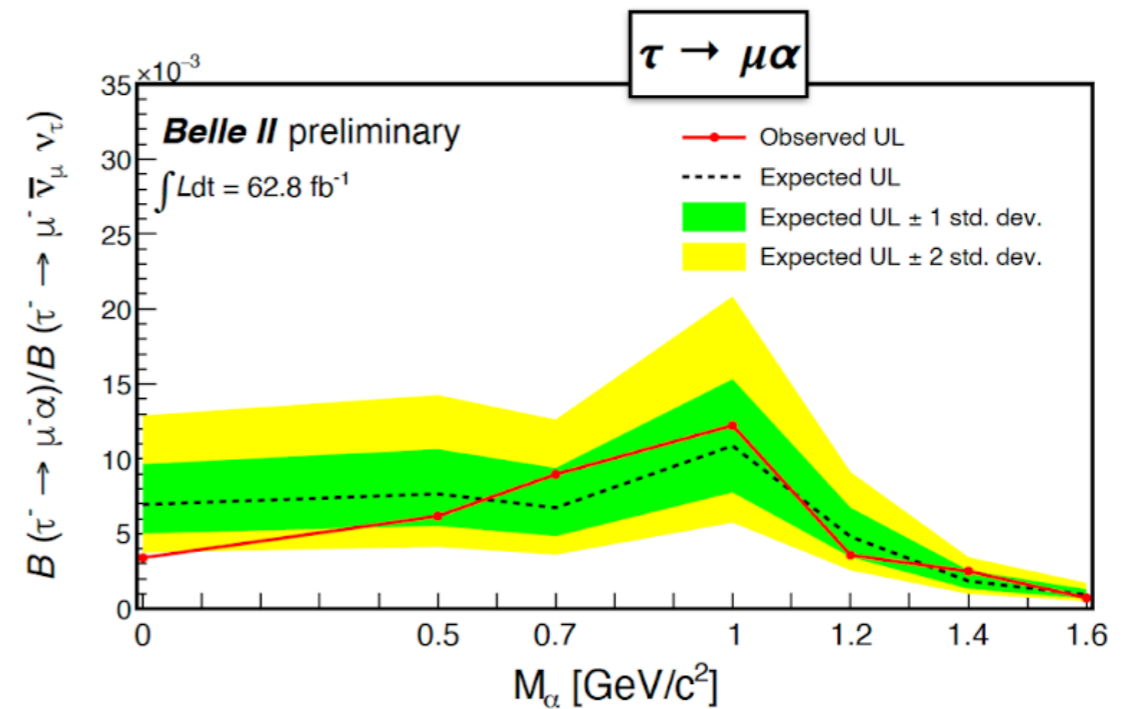
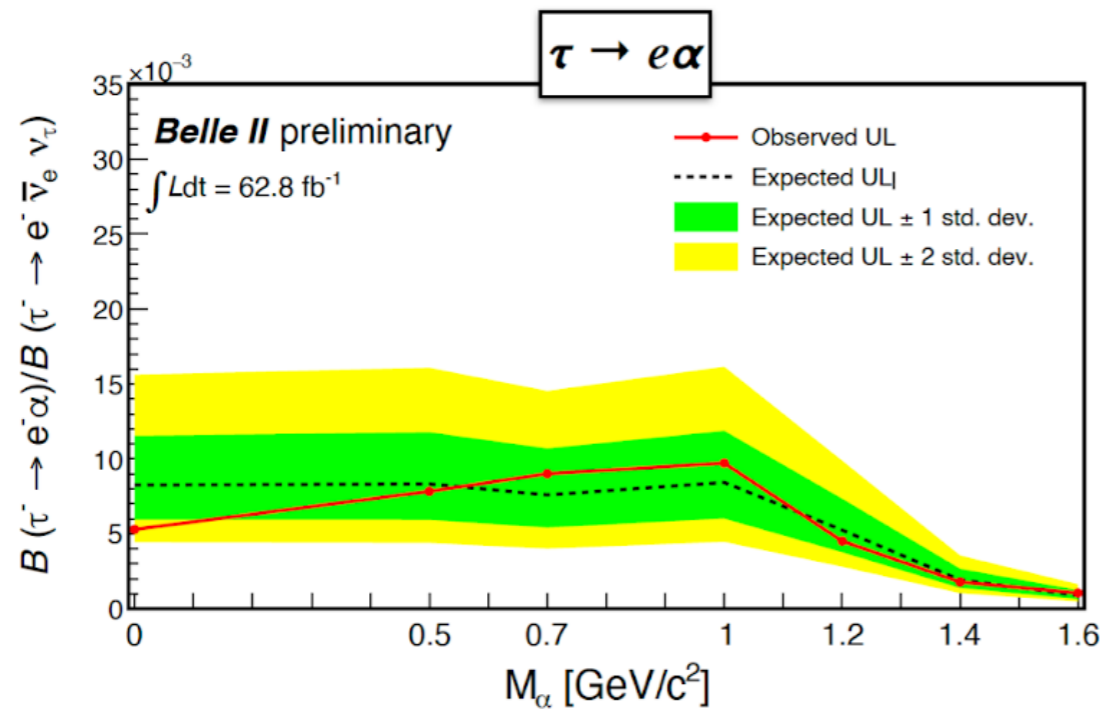

Comparison with previous limits from ARGUS (0.472 fb⁻¹) [Z. Phys. C68 (1995) 25]

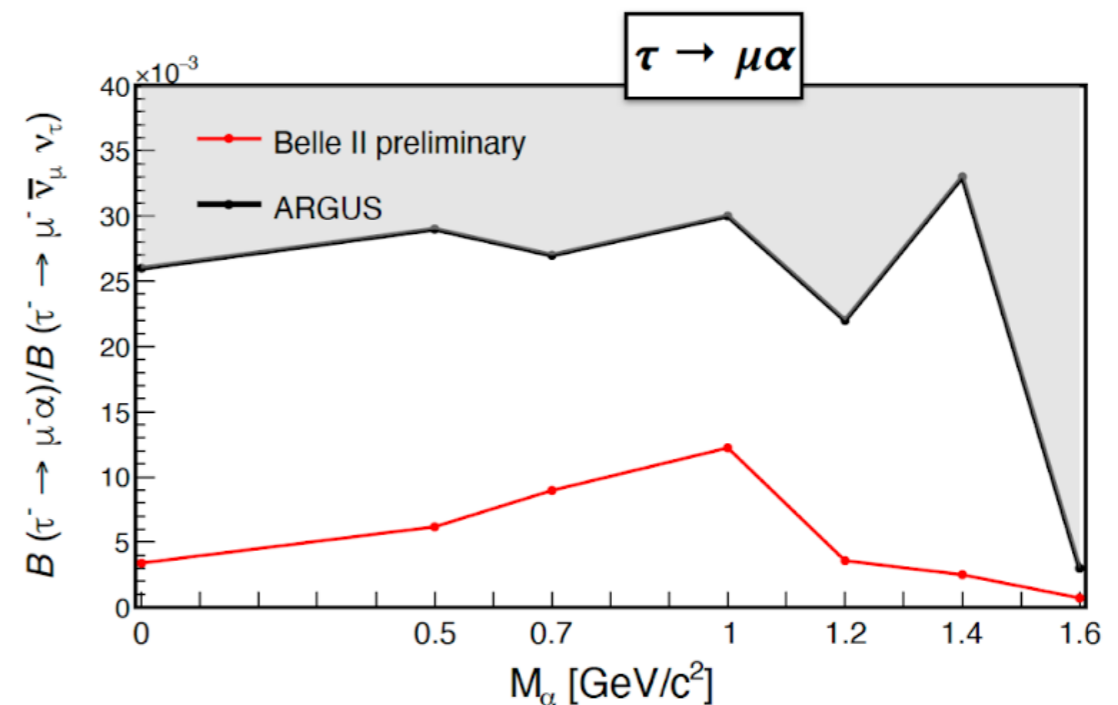
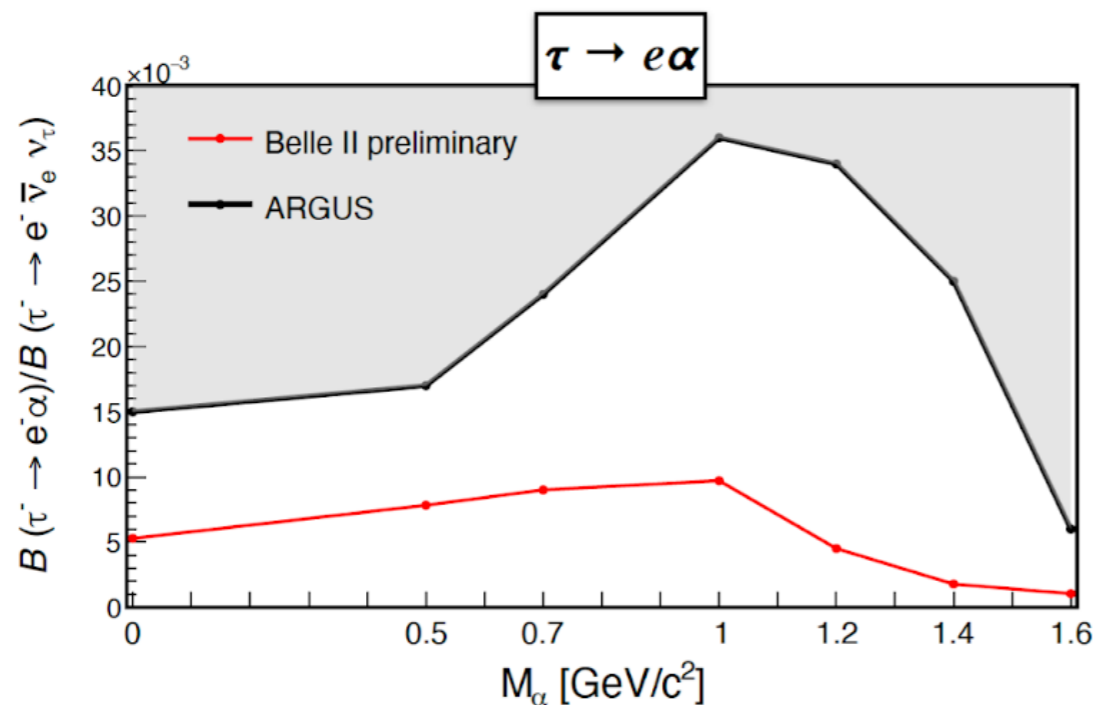

Estimates of experimental sensitivity in LFV searches

$$B_{UL}^{90} = N_{UL}^{90} / (N_{\tau} \times \epsilon)$$

- ϵ : high statistics signal MC simulated for different Data-taking periods

$\epsilon =$ Trigger . Reco . Topology . PID . Cuts . Signal-Box

90% 70% 70% 50% 50% 50%

Cumulative:

90% 63% 44% 22% 11% ~5%

	\sqrt{s}	Luminosity (L)	$N_{\tau} = 2L\sigma$
Belle II	10.58 GeV	50 ab ⁻¹	9.2 x10 ¹⁰
HL-LHC	14 TeV	3 ab ⁻¹	$\mathcal{O}(10^{15})$
STCF	2-7 GeV	1 ab ⁻¹	7.0 x10 ⁹
FCC-ee	91.2 GeV	150 ab ⁻¹	3.4 x 10 ¹¹

(Efficiency much lower)

Current status of LFV τ decays $\sim 10^{-7}$

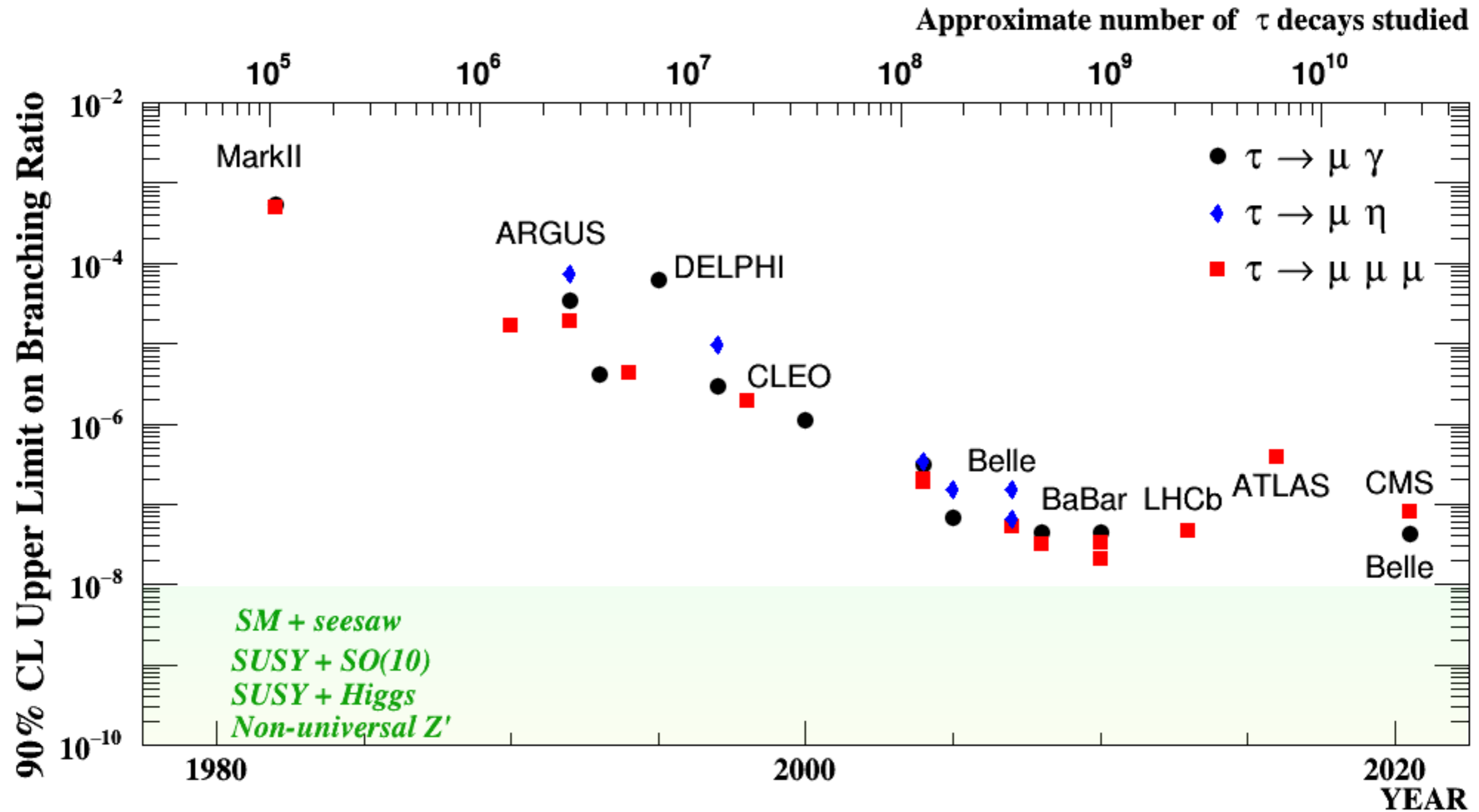

$\tau \rightarrow \mu\mu\mu$ at Belle II

- Known initial conditions (beam energy constraint)
- Clean environment (fewer backgrounds)

Two independent variables:

$$M_\tau = \sqrt{E_{\mu\mu\mu}^2 - P_{\mu\mu\mu}^2}$$

$$\Delta E = E_{\mu\mu\mu}^{CMS} - E_{\text{beam}}^{CMS}$$

- ➔ ΔE close to 0 for signal
- ➔ Mass of tau daughters close to τ mass

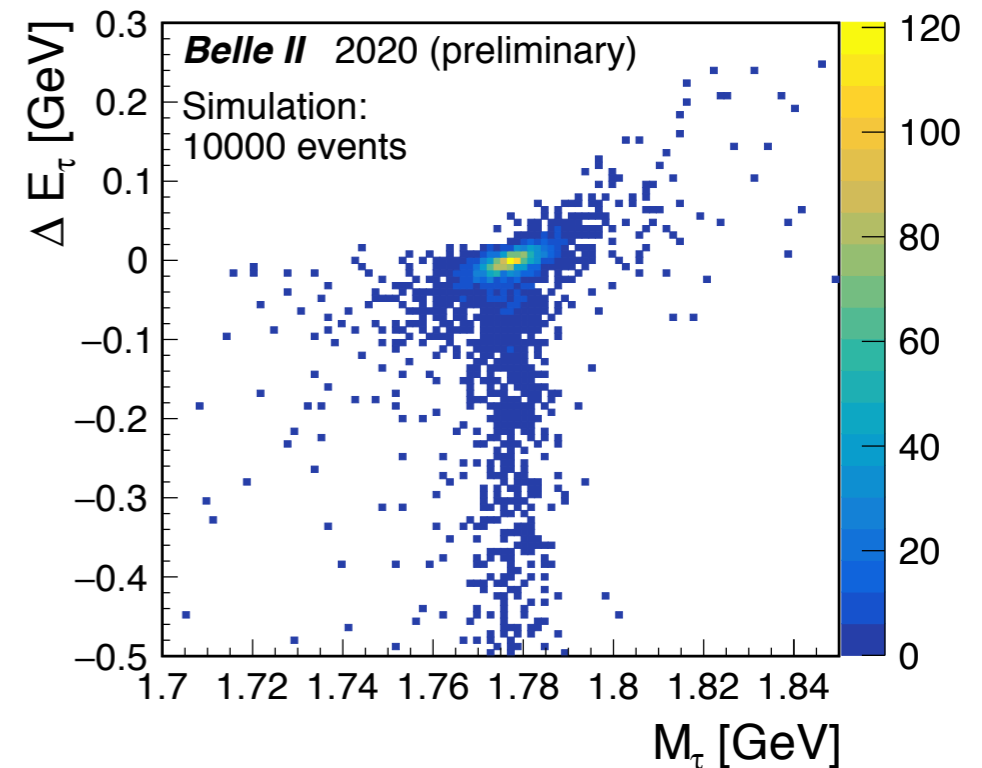

Higher signal efficiency is foreseen at Belle II than at Belle or BaBar

- higher trigger efficiencies
- improved vertexing detectors
- upgraded tracking /calorimetry
- momentum dependent particle identification optimizations

Expected Belle II sensitivity: $\mathcal{B}(\tau \rightarrow \mu\mu\mu) < 3.6 \times 10^{-10}$ with 50 ab^{-1}

Projected limits at Belle II

	Background limited search	Background free search
N_{UL}^{90}	$\sqrt{\mathcal{L}}$	2.44 [Feldman – Cousins for $N_{obs} = 0$]
B_{UL}^{90}	$\propto 1/\sqrt{\mathcal{L}}$	$\propto 1/\mathcal{L}$

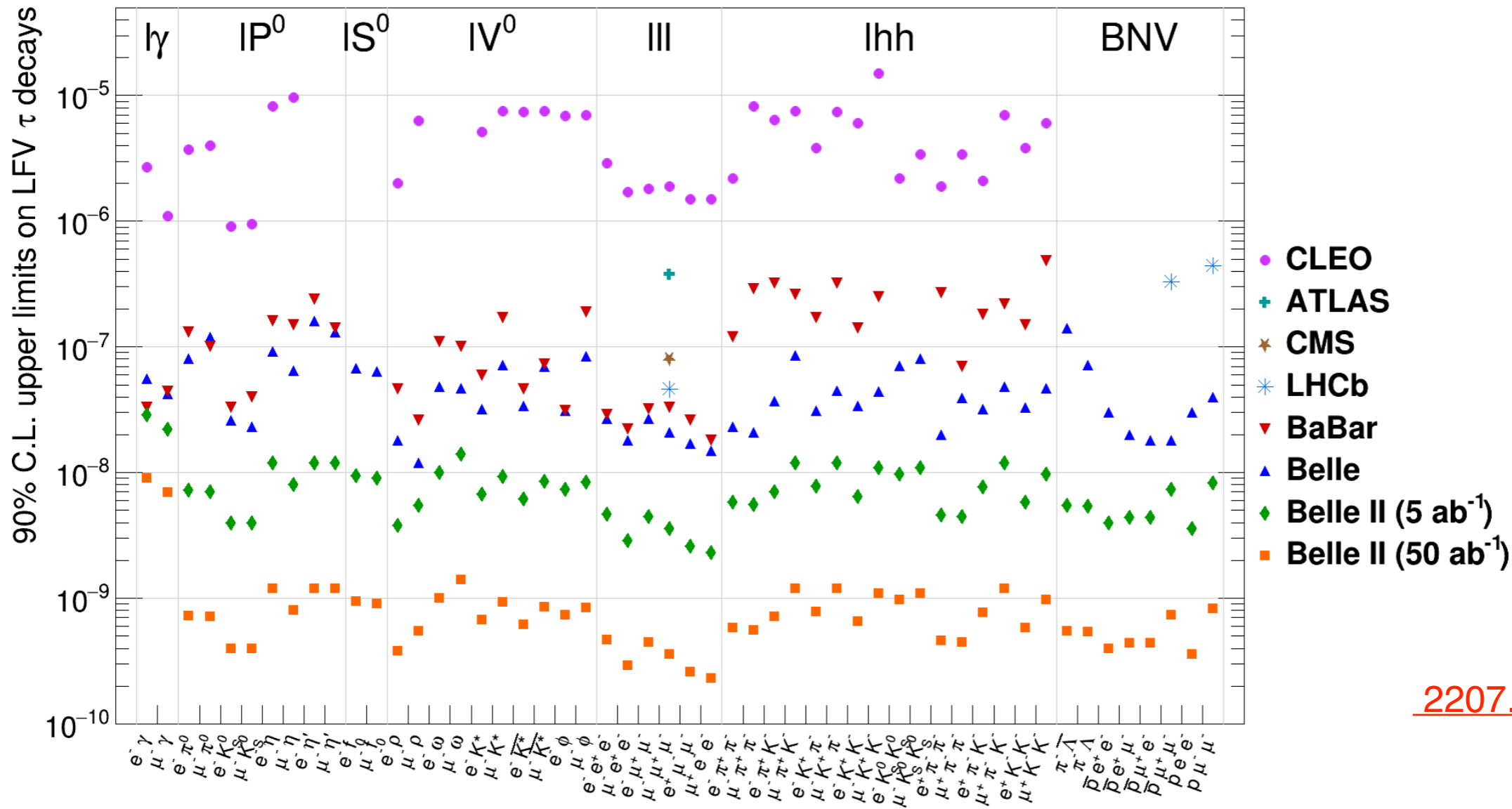

Projections

[2207.06306 \[hep-ex\]](https://arxiv.org/abs/2207.06306)

Belle II to probe LFV in several channels $\approx \mathcal{O}(10^{-10})$ to $\mathcal{O}(10^{-9})$ with 50 ab^{-1}

Beam polarization upgrade at SuperKEKB/Belle II

- Further improvements are expected with polarized beams
- With beam polarization, helicity distributions can suppress backgrounds
- Optimization study shows at least 10% improvement in $\tau \rightarrow \ell \gamma$ sensitivity

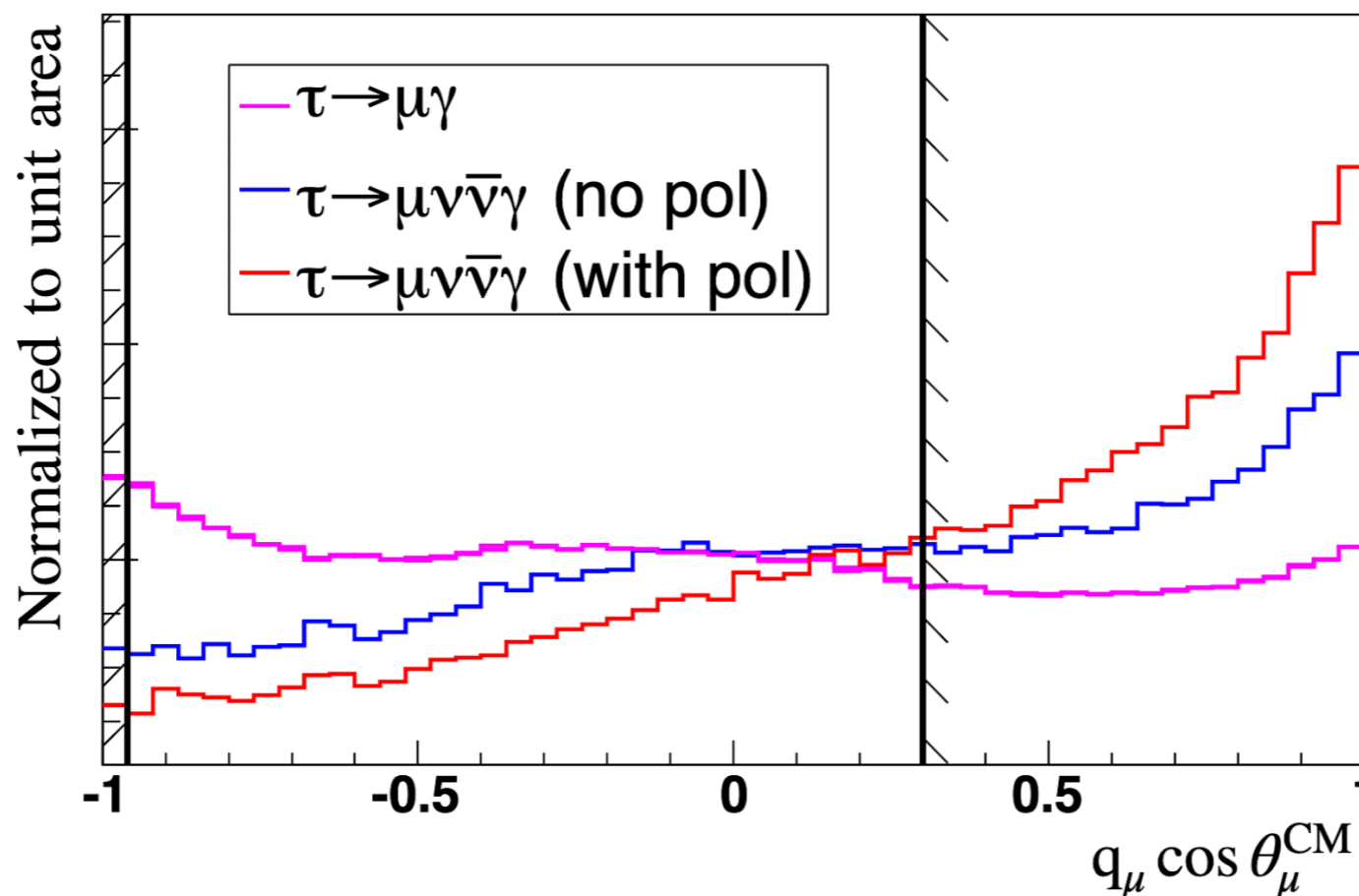

<https://arxiv.org/pdf/0810.1312.pdf>

Intriguing aspect of having the polarization is the possibility to determine the helicity structure of the LFV coupling in $\tau \rightarrow \mu \mu \mu$ from Dalitz plots.

$\tau \rightarrow \mu\mu\mu$ at LHCb

Using D decays (3fb^{-1} at 7/8 TeV)

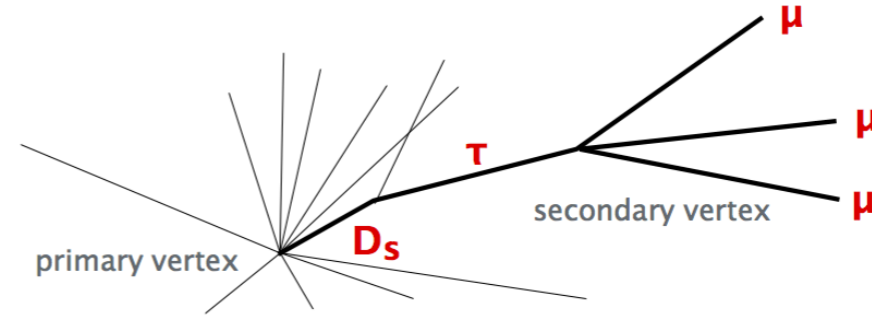

$$\mathcal{B}(\tau^- \rightarrow \mu^- \mu^+ \mu^-) = \frac{\mathcal{B}(D_s^- \rightarrow \phi(\mu^+ \mu^-) \pi^-)}{\mathcal{B}(D_s^- \rightarrow \tau^- \bar{\nu}_\tau)} \times f_\tau^{D_s} \times \frac{\epsilon_{\text{cal}}^{\text{R}}}{\epsilon_{\text{sig}}^{\text{R}}} \times \frac{\epsilon_{\text{cal}}^{\text{T}}}{\epsilon_{\text{sig}}^{\text{T}}} \times \frac{N_{\text{sig}}}{N_{\text{cal}}} \equiv \alpha N_{\text{sig}}$$

► LHCb limit on the $\tau^- \rightarrow \mu^- \mu^+ \mu^-$ branching ratio

$$\mathcal{B}(\tau^- \rightarrow \mu^- \mu^+ \mu^-) < 4.6 \times 10^{-8} \quad @ 90\% \text{ C.L.}$$

[JHEP 02 \(2015\) 121](#)

LHCb-PUB-2018-009

The cross-section is five orders of magnitude larger than at Belle II. This compensates for the higher background levels and lower integrated luminosity. As pointed out in [76], during the HL-LHC era, the LHCb Upgrade II detector will allow to collect 300fb^{-1} . With this large data sample, LHCb will be able to probe the branching ratio down to $O(10^{-9})$, and either independently confirm any Belle II discovery or significantly improve the limit.

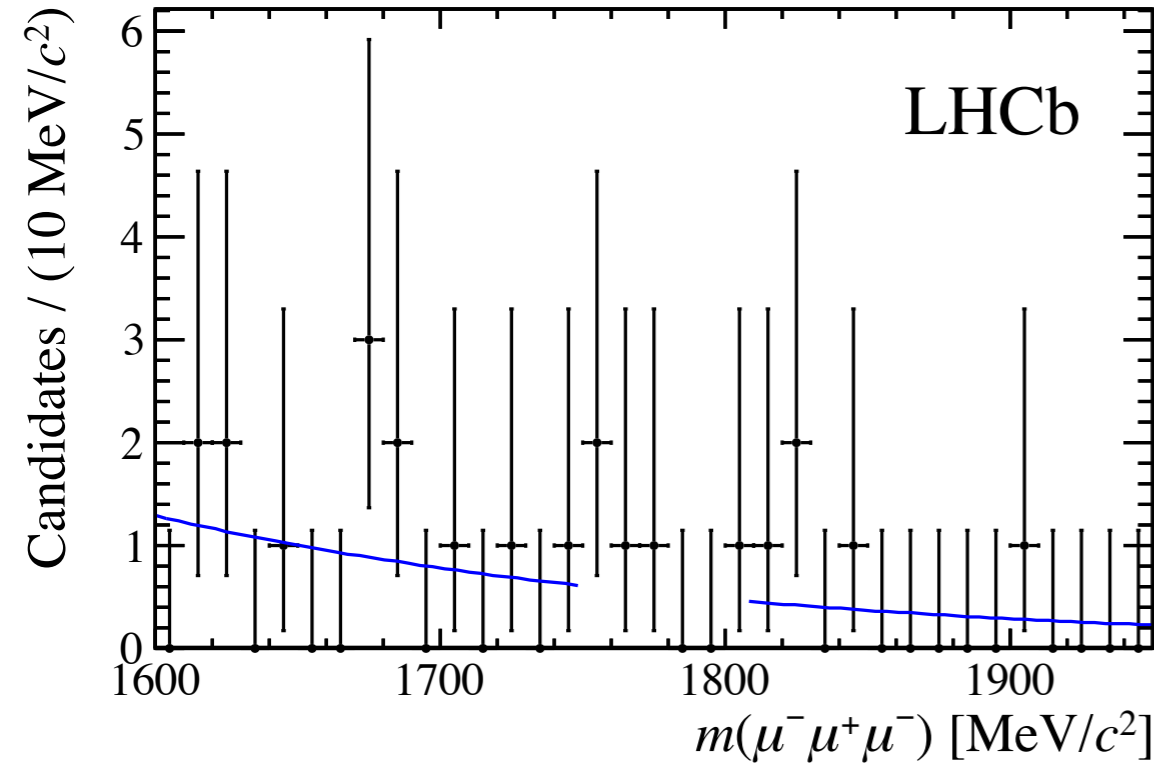

$\tau \rightarrow \mu\mu\mu$ at ATLAS & CMS

- ▶ ATLAS limit on the $\tau^- \rightarrow \mu^- \mu^+ \mu^-$ branching ratio

(20 fb⁻¹ at 8 TeV)

$$\mathcal{B}(\tau^- \rightarrow \mu^- \mu^+ \mu^-) < 3.76 \times 10^{-7} \quad @ 90\% \text{ C.L.}$$

[Eur. Phys. J. C \(2016\) 76:232](#)

- ▶ CMS limit on the $\tau^- \rightarrow \mu^- \mu^+ \mu^-$ branching ratio

(33 fb⁻¹ at 13 TeV)

$$\mathcal{B}(\tau^- \rightarrow \mu^- \mu^+ \mu^-) < 8.0 \times 10^{-8} \quad @ 90\% \text{ C.L.}$$

[JHEP 01 \(2021\) 163](#)

Future prospects using D & B decays (3 ab⁻¹ at 14 TeV) :

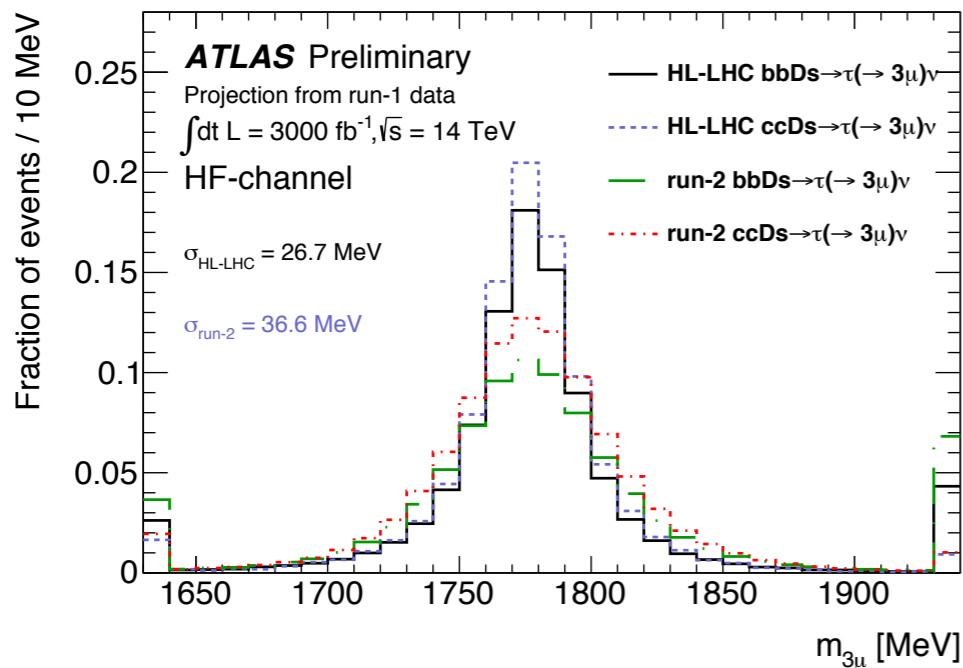

[ATL-PHYS-PUB-2018-032](#)

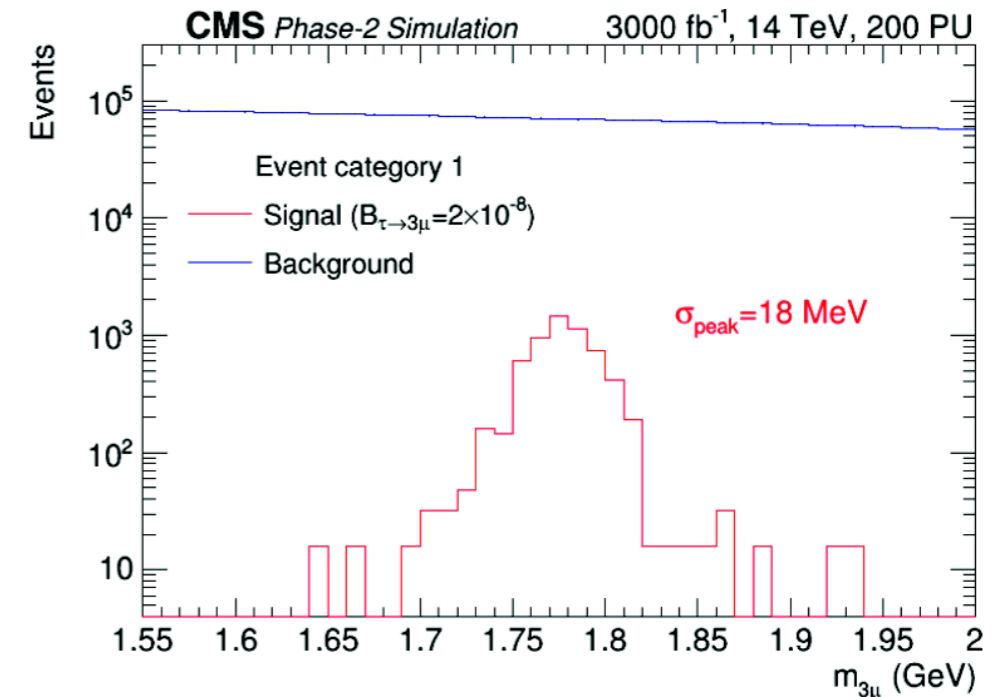

[CMS-TDR-016](#)

Scenario	$\mathcal{A} \times \epsilon$ [%]	$N_{\text{bkg}}^{\text{exp}}$	90% CL UL on BR($\tau \rightarrow 3\mu$) [10^{-9}]
High background	0.88	507.05	6.40
Medium background	0.88	152.12	2.31
Low background	0.88	50.71	1.03

	Category 1	Category 2
Number of background events	2.4×10^6	2.6×10^6
Number of signal events	4580	3640
Trimuon mass resolution	18 MeV	31 MeV
$B(\tau \rightarrow 3\mu)$ limit per event category	4.3×10^{-9}	7.0×10^{-9}
$B(\tau \rightarrow 3\mu)$ 90% C.L. limit	3.7×10^{-9}	

Super Tau-Charm Facility

“Physics Potential of a Super tau-Charm Facility” (RF/SNOWMASS21-RF7 RF1 STCF-013.pdf)

- Peaking luminosity $>0.5 \times 10^{35} \text{ cm}^{-2}\text{s}^{-1}$ at 4 GeV
- Energy range $E_{\text{cm}} = 2\text{-}7 \text{ GeV}$
- **Potential** to increase luminosity and realize beam polarization
- A nature extension and a viable option for China accelerator project in the post BEPCII/BESIII era

PoS CHARM2020 (2021), 007

Physics 49 (2020) 8, 513-524

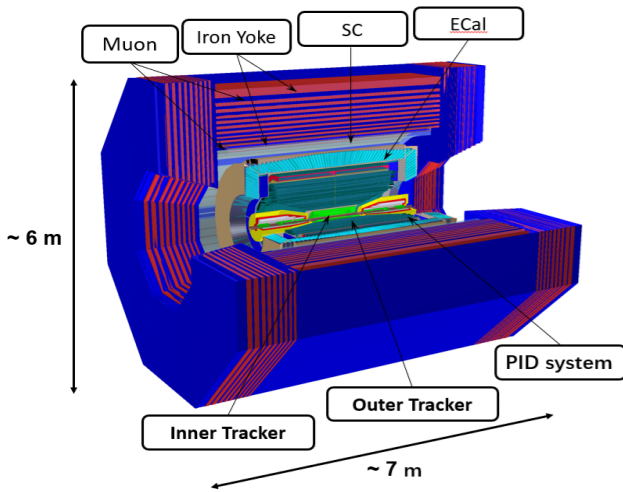
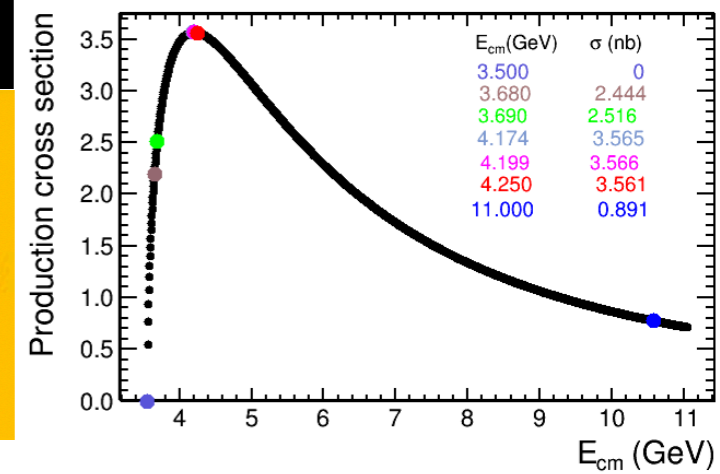

At 4.26 GeV, number of tau pairs per year: $N_{\tau\tau} \sim 1.0 \text{ ab}^{-1} \times 3.5 \text{ nb} = 3.5 \times 10^9$

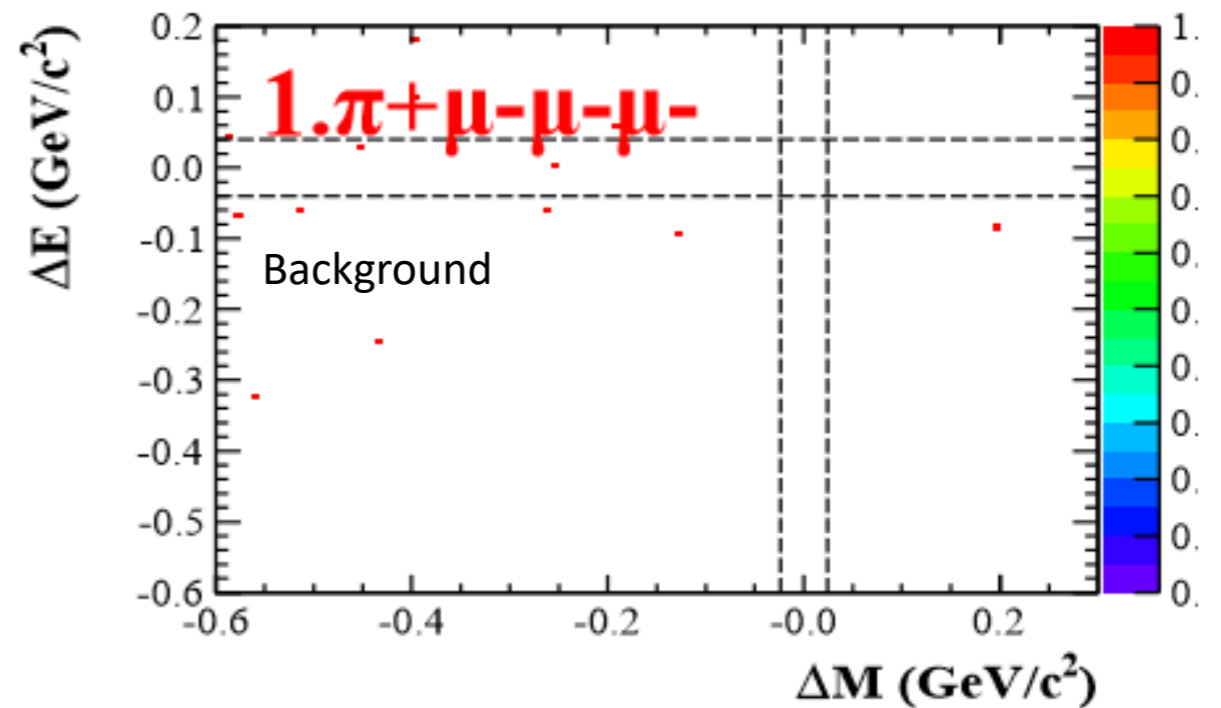
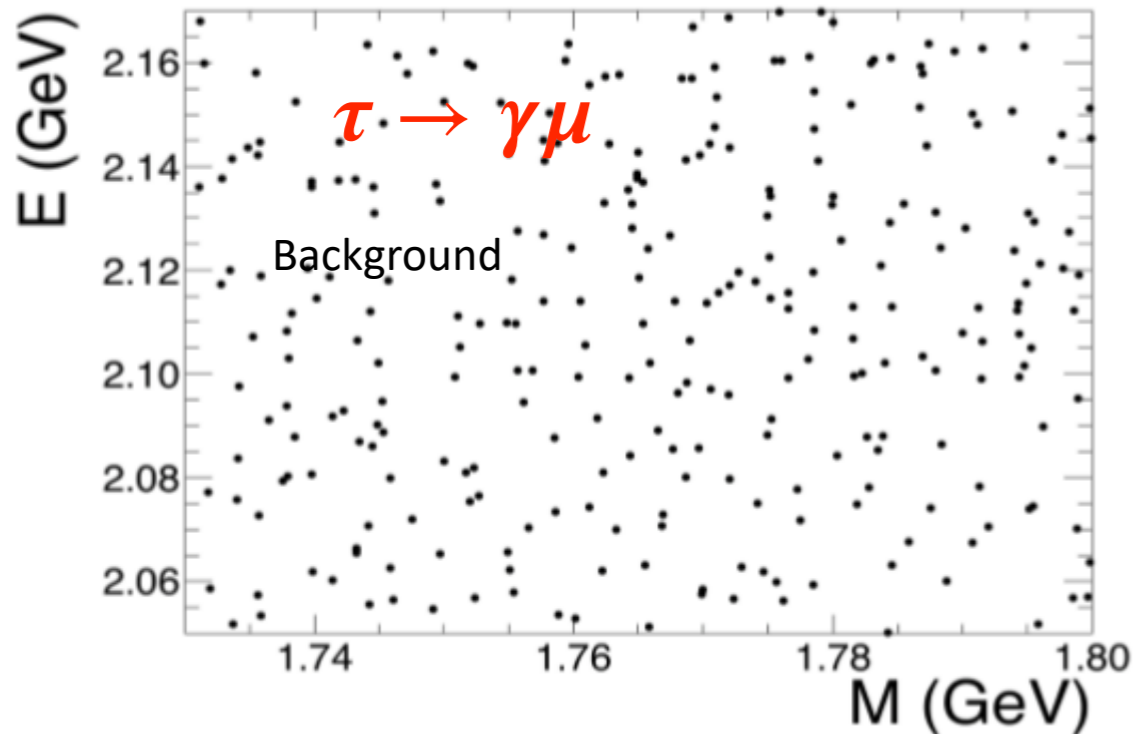

> STCF with 1 ab^{-1} :

$$\mathcal{B}_{UL}^{90}(\tau \rightarrow \gamma\mu) < \frac{N_{UL}^{90}}{2\epsilon N_{\tau\tau}} \sim 1.2 \times 10^{-8}$$

> STCF with 1 ab^{-1} :

$$\mathcal{B}_{UL}^{90}(\tau \rightarrow \mu\mu\mu) < \frac{N_{UL}^{90}}{2\epsilon N_{\tau\tau}} \sim 1.4 \times 10^{-9}$$

$e \rightarrow \tau$ transitions at EIC

Sensitivity study with 100 fb^{-1} of data to be collected at $\sqrt{s} = 140 \text{ GeV}$ (18 GeV electron on 275 GeV protons)

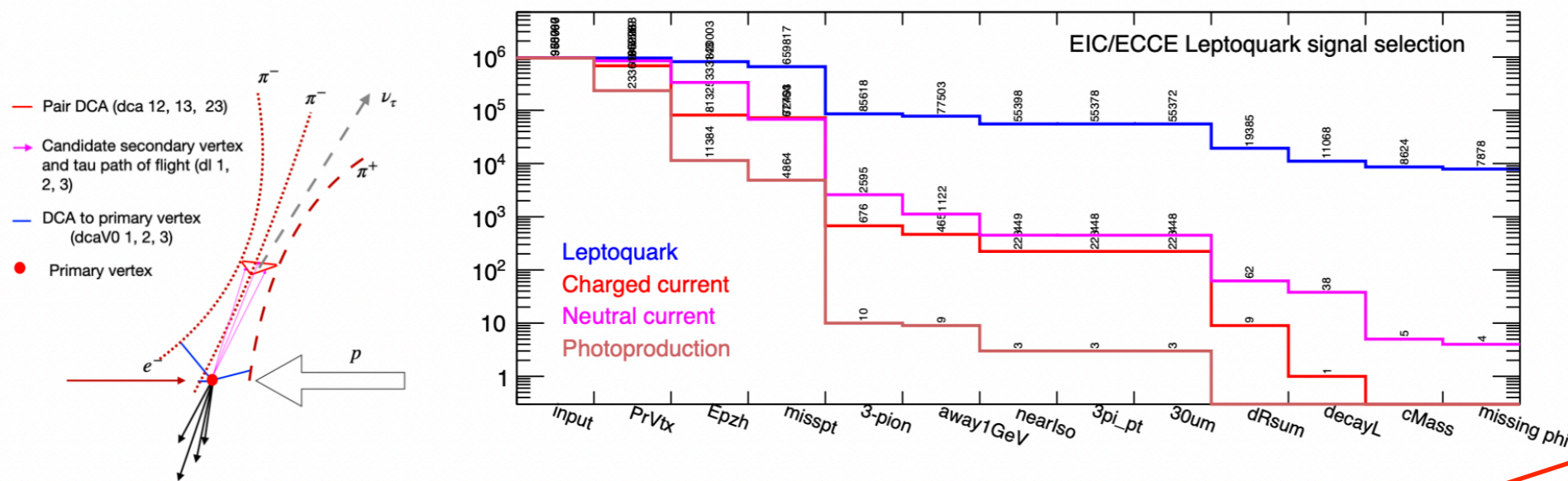

e-Print: [2207.10261 \[hep-ph\]](https://arxiv.org/abs/2207.10261)

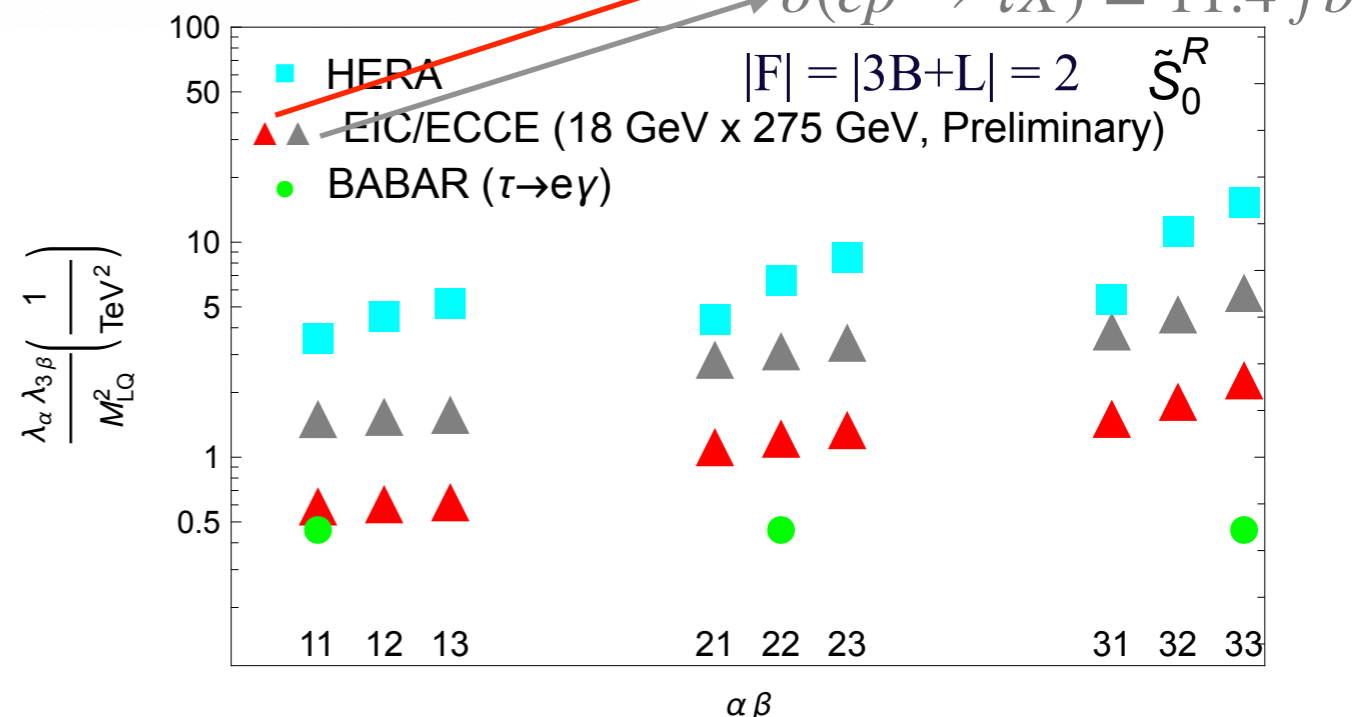
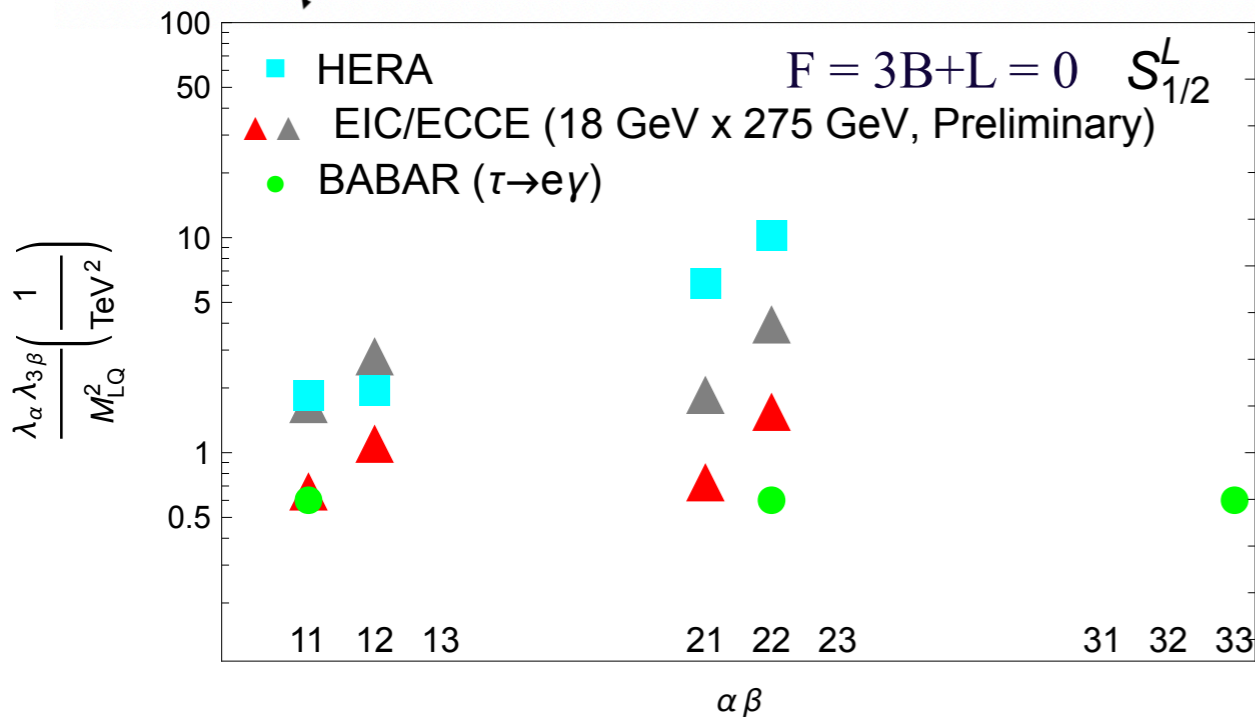

Expect to improve current sensitivity by an order of magnitude



$$\mathcal{B}(\tau \rightarrow \mu\gamma)$$

e-Print: [1811.09408 \[hep-ex\]](https://arxiv.org/abs/1811.09408)

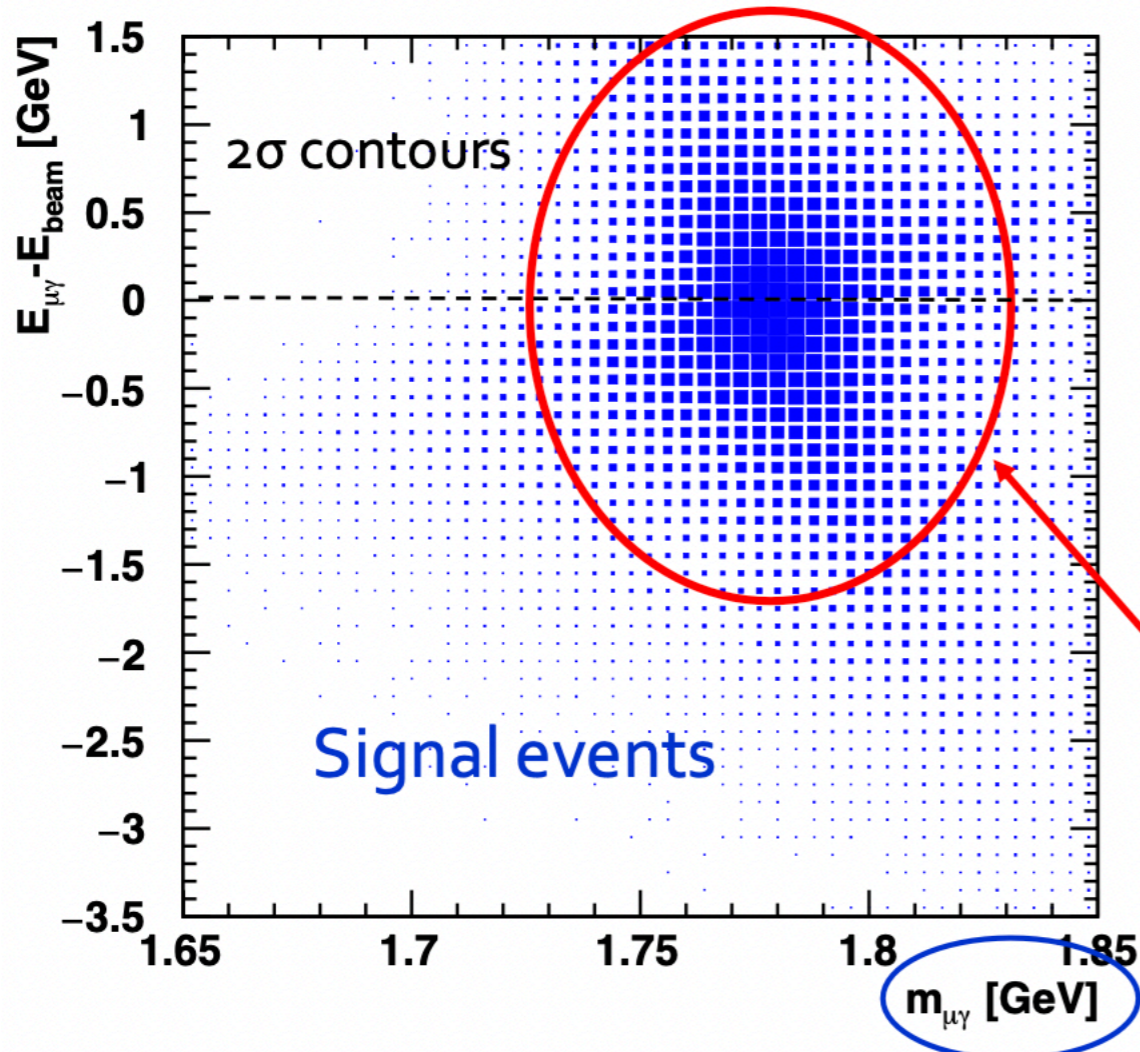

- ◆ **Main background:** Radiative events (IRS+FSR), $e^+e^- \rightarrow \tau^+\tau^-\gamma$
 - $\tau \rightarrow \mu\gamma$ decay faked by combination of γ from ISR/FSR and μ from $\tau \rightarrow \mu\nu\bar{\nu}$

Smear with assumed FCC-ee detector resolutions (ILC-like detector):

- Muon momentum [GeV]

$$\sigma(p_T)/p_T = 2 \times 10^{-5} \times p_T \oplus 1 \times 10^{-3}$$
- Photon ECAL energy [GeV]

$$\sigma(E)/E = 0.165/\sqrt{E} \oplus 0.010/E \oplus 0.011$$
- Photon ECAL spatial [mm]

$$\sigma(x) = \sigma(y) = (6/E \oplus 2) \text{ mm}$$

$\sigma(m_{\gamma\mu}) = 26 \text{ MeV}; \quad \sigma(E_{\gamma\mu}) = 850 \text{ MeV}$

□ From study (assuming 25% signal & background efficiency), projected BR sensitivity

2×10^{-9}

$$\mathcal{B}(\tau \rightarrow \mu\mu\mu)$$

- Expect this search to have *very low* background, even with FCC-ee like statistics
- Should be able to have sensitivity down to BRs of $\lesssim 10^{-10}$

Summary of experimental prospects of τ decays

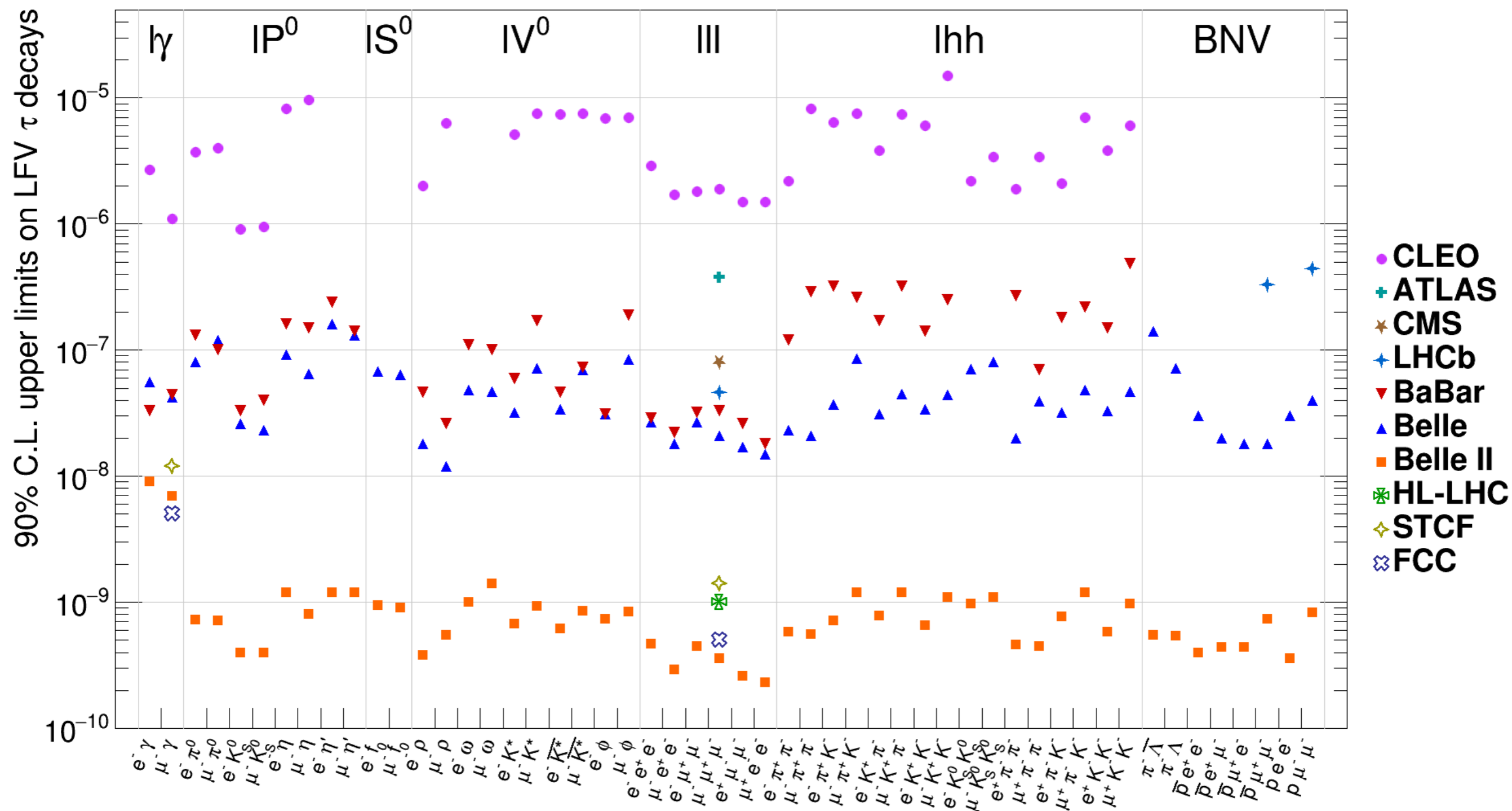

e-Print: [2203.14919 \[hep-ph\]](https://arxiv.org/abs/2203.14919)

Summary of transitions with τ in the final state

Channel	Upper limit	Experiment [Ref.]
$J/\psi \rightarrow e^\pm \tau^\mp$	7.5×10^{-8}	BES III [108]
$J/\psi \rightarrow \mu^\pm \tau^\mp$	2.0×10^{-6}	BES [109]
$B^0 \rightarrow e^\pm \tau^\mp$	2.8×10^{-5}	BaBar [110]
$B^0 \rightarrow \mu^\pm \tau^\mp$	2.2×10^{-5}	BaBar [110]
	1.2×10^{-5}	LHCb [62]
$B^+ \rightarrow \pi^+ e^\pm \tau^\mp$	7.5×10^{-5}	BaBar [111]
$B^+ \rightarrow \pi^+ \mu^\pm \tau^\mp$	7.2×10^{-5}	BaBar [111]
$B^+ \rightarrow K^+ e^\pm \tau^\mp$	3.0×10^{-5}	BaBar [111]
$B^+ \rightarrow K^+ \mu^\pm \tau^\mp$	4.8×10^{-5}	BaBar [111]
$B^+ \rightarrow K^+ \mu^- \tau^+$	3.9×10^{-5}	LHCb [63]
$B_s^0 \rightarrow \mu^\pm \tau^\mp$	3.4×10^{-5}	LHCb [62]
$\Upsilon(1S) \rightarrow e^\pm \tau^\mp$	2.7×10^{-6}	Belle [112]
$\Upsilon(1S) \rightarrow \mu^\pm \tau^\mp$	2.7×10^{-6}	Belle [112]
$\Upsilon(2S) \rightarrow e^\pm \tau^\mp$	3.2×10^{-6}	BaBar [113]
$\Upsilon(2S) \rightarrow \mu^\pm \tau^\mp$	3.3×10^{-6}	BaBar [113]
$\Upsilon(3S) \rightarrow e^\pm \tau^\mp$	4.2×10^{-6}	BaBar [113]
$\Upsilon(3S) \rightarrow \mu^\pm \tau^\mp$	3.1×10^{-6}	BaBar [113]
$Z \rightarrow e^\pm \tau^\mp$	5.0×10^{-6} (*)	ATLAS [69]
$Z \rightarrow \mu^\pm \tau^\mp$	6.5×10^{-6} (*)	ATLAS [69]
$H \rightarrow e^\pm \tau^\mp$	0.47% (*)	ATLAS [65]
	0.22% (*)	CMS [66]
$H \rightarrow \mu^\pm \tau^\mp$	0.28% (*)	ATLAS [65]
	0.15% (*)	CMS [66]
	26% (*)	LHCb [64]

Table 2: Bounds on selected LFV decays with τ in the final state are shown at 90% CL, except for limits on those decays marked with a (*), which are quoted at 95% CL.

[e-Print: 2203.14919 \[hep-ph\]](https://arxiv.org/abs/2203.14919)

LFV decays of Higgs Boson

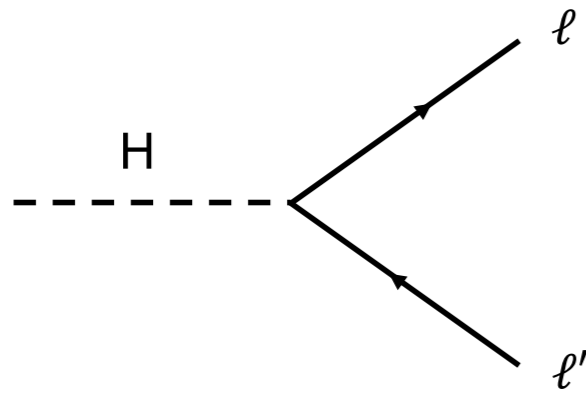

Yukawa off-diagonal terms

$$\mathcal{L}_Y = -m_i \bar{f}_L^i f_R^i - Y_{ij} (\bar{f}_L^i f_R^j) h + h.c. + \dots,$$

In the SM: $Y_{ij} = (m_i/v)\delta_{ij}$

ATLAS

[Phys. Lett. B 800 \(2020\) 135069](#)

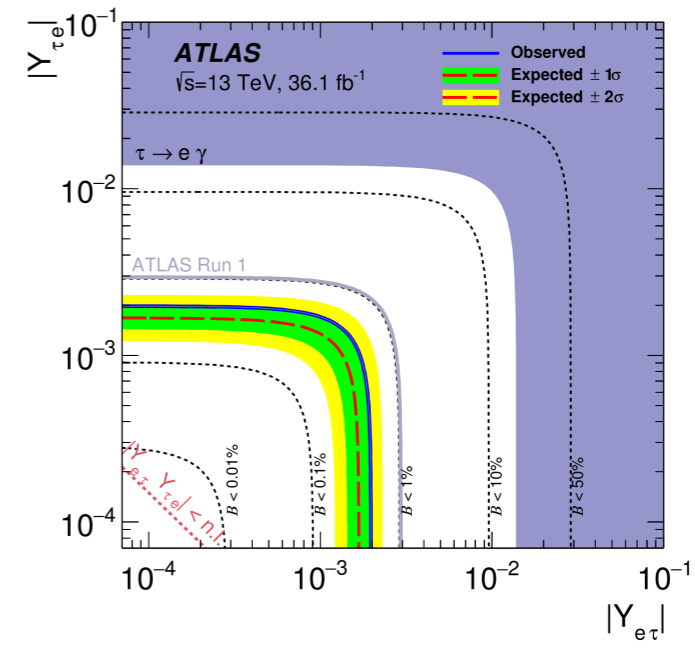
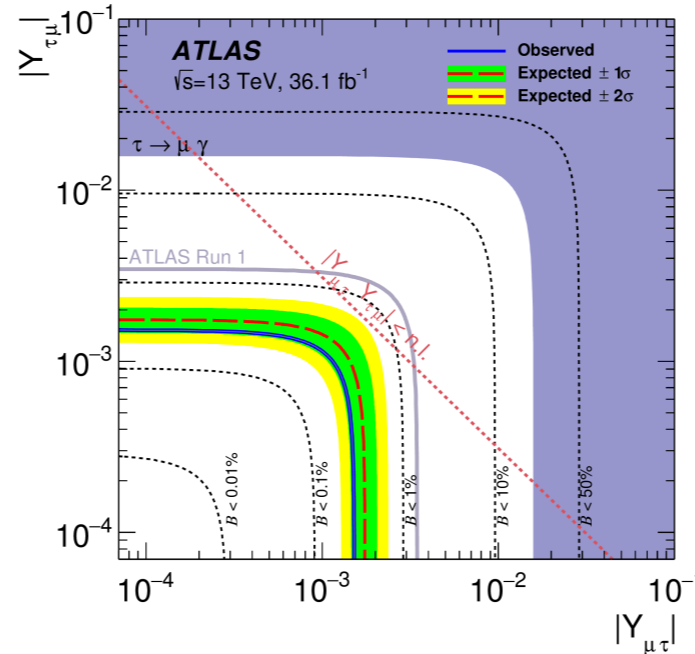

CMS

[Phys. Rev. D 104 \(2021\) 032013](#)

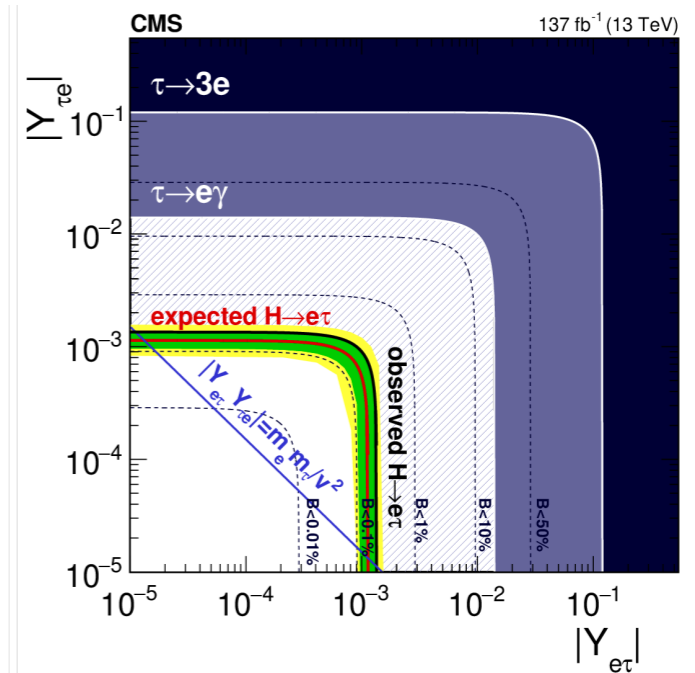
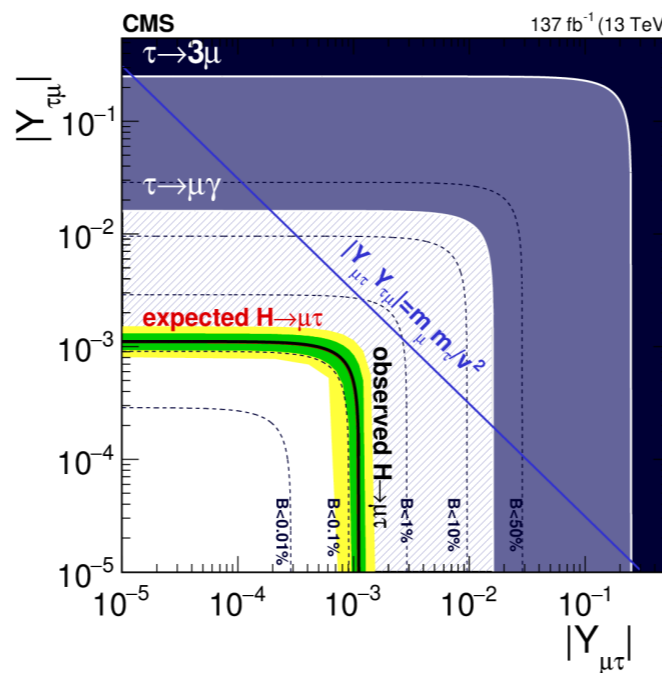

Global fit: $\tau \rightarrow e$ decays and transitions with τ in the final state

Model-independent probes of new physics at scale (Λ) encoded as Wilson coefficients (C_n) via EFT approach.
 For certain operators, Higgs decay and LFV Drell-Yan compete, which are assumed to scale by factor of 4 at HL-LHC.
 For many other operators, bounds dominated by τ and B-decays.

More:
 E. Mereghetti's
 talk on 3 Sep'22

Upper limit on LFV coupling and lower limit on new physics scale

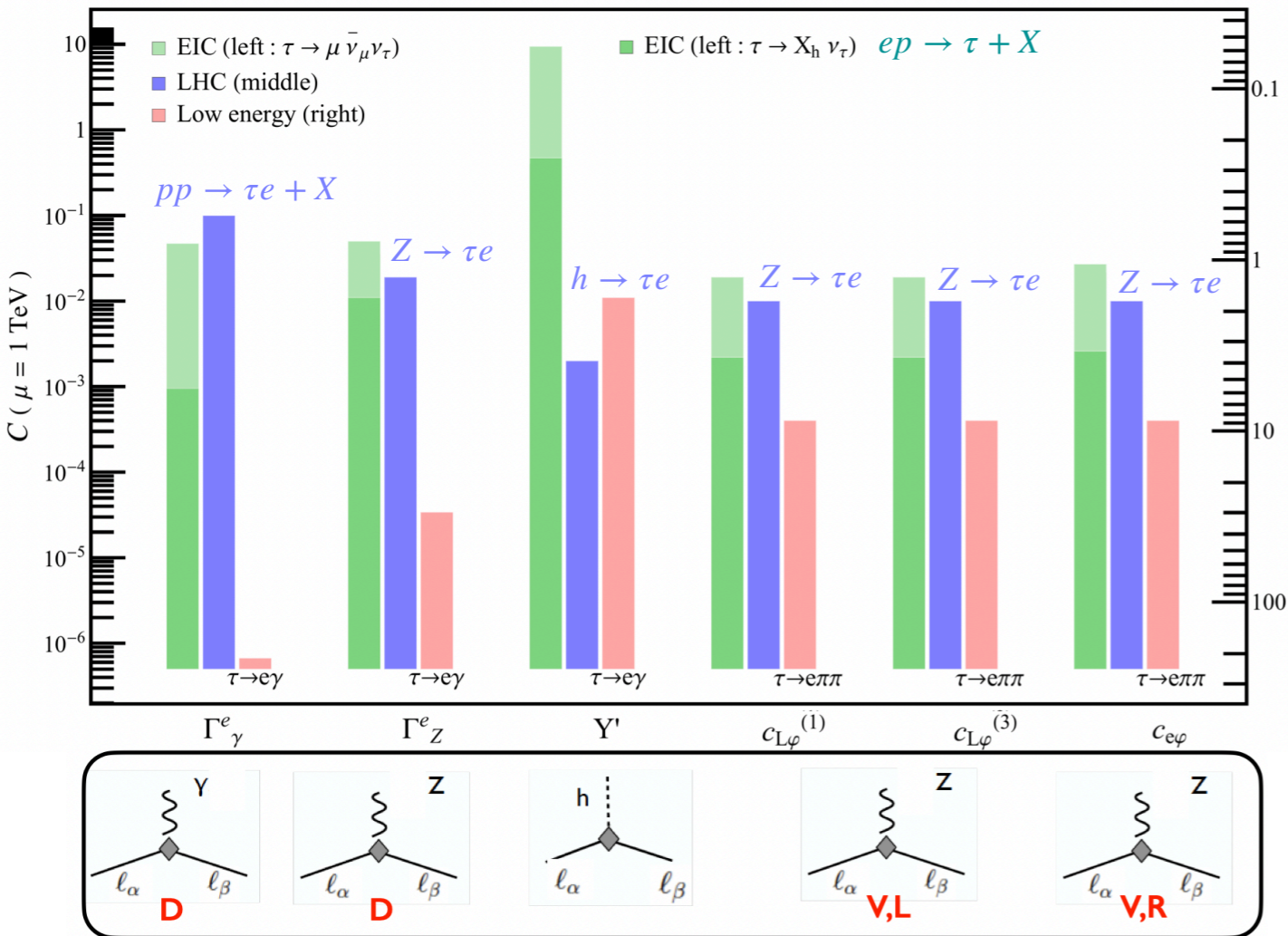

e-Print: 2102.06176 [hep-ph]

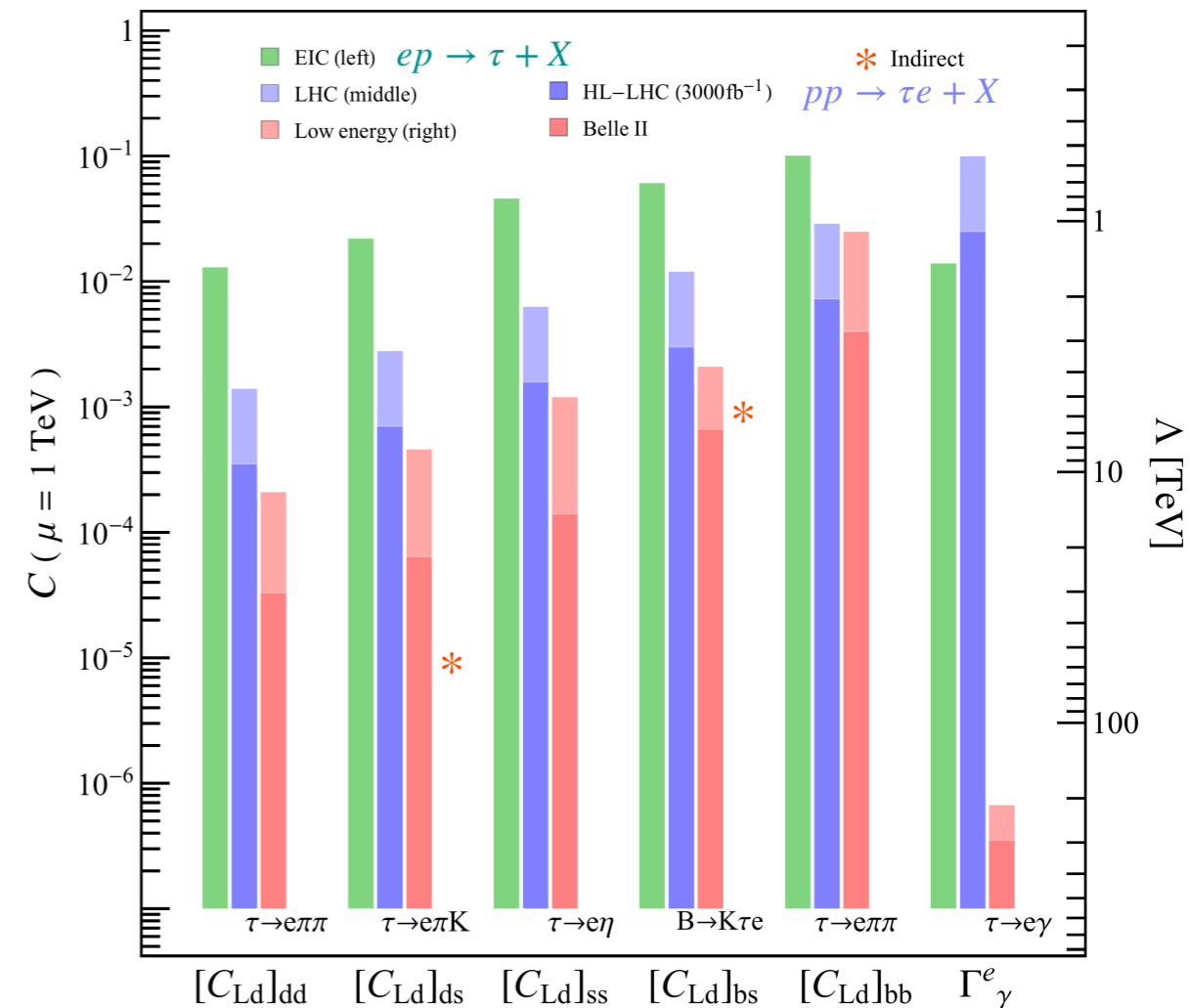

e-Print: 2203.14919 [hep-ph]

Global fit: $\tau \rightarrow \mu$ decays and transitions with τ in the final state

Model-independent probes of new physics at scale (Λ) encoded as Wilson coefficients (C_n) via EFT approach.
 For certain operators, Higgs decay and LFV Drell-Yan compete, which are assumed to scale by factor of 4 at HL-LHC.
 For many other operators, bounds dominated by τ and B-decays.

WC	Operator	WC	Operator
$C_{LQ}^{(1)}$	$(\bar{L}_p \gamma_\mu L_r) (\bar{Q}_s \gamma^\mu Q_t)$	$C_{e\varphi}$	$(\varphi^\dagger \varphi) (\bar{L}_p e_r \varphi)$
$C_{LQ}^{(3)}$	$(\bar{L}_p \gamma_\mu \sigma^I L_r) (\bar{Q}_s \gamma^\mu \sigma^I Q_t)$	$C_{\varphi e}$	$(\varphi^\dagger i \overleftrightarrow{D}_\mu \varphi) (e_p \gamma^\mu e_r)$
C_{eu}	$(\bar{e}_p \gamma_\mu e_r) (\bar{u}_s \gamma^\mu u_t)$	$C_{\varphi L}^{(1)}$	$(\varphi^\dagger i \overleftrightarrow{D}_\mu \varphi) (\bar{L}_p \gamma^\mu L_r)$
C_{ed}	$(\bar{e}_p \gamma_\mu e_r) (\bar{d}_s \gamma^\mu d_t)$	$C_{\varphi L}^{(3)}$	$(\varphi^\dagger i \overleftrightarrow{D}_{I\mu} \varphi) (\bar{L}_p \sigma_I \gamma^\mu L_r)$
C_{Lu}	$(\bar{L}_p \gamma_\mu L_r) (\bar{u}_s \gamma^\mu u_t)$	C_{eW}	$(\bar{L}_p \sigma^{\mu\nu} e_r) \sigma_I \varphi W_{\mu\nu}^I$
C_{Ld}	$(\bar{L}_p \gamma_\mu L_r) (\bar{d}_s \gamma^\mu d_t)$	C_{eB}	$(\bar{L}_p \sigma^{\mu\nu} e_r) \varphi B_{\mu\nu}$
C_{Qe}	$(\bar{Q}_p \gamma_\mu Q_r) (\bar{e}_s \gamma^\mu e_t)$		
C_{LedQ}	$(\bar{L}_p^j e_r) (\bar{d}_s Q_t^j)$		
$C_{LeQu}^{(1)}$	$(\bar{L}_p^j e_r) \varepsilon_{jk} (\bar{Q}_s^k u_t)$		
$C_{LeQu}^{(3)}$	$(\bar{L}_p^j \sigma_{\mu\nu} e_r) \varepsilon_{jk} (\bar{Q}_s^k \sigma^{\mu\nu} u_t)$		

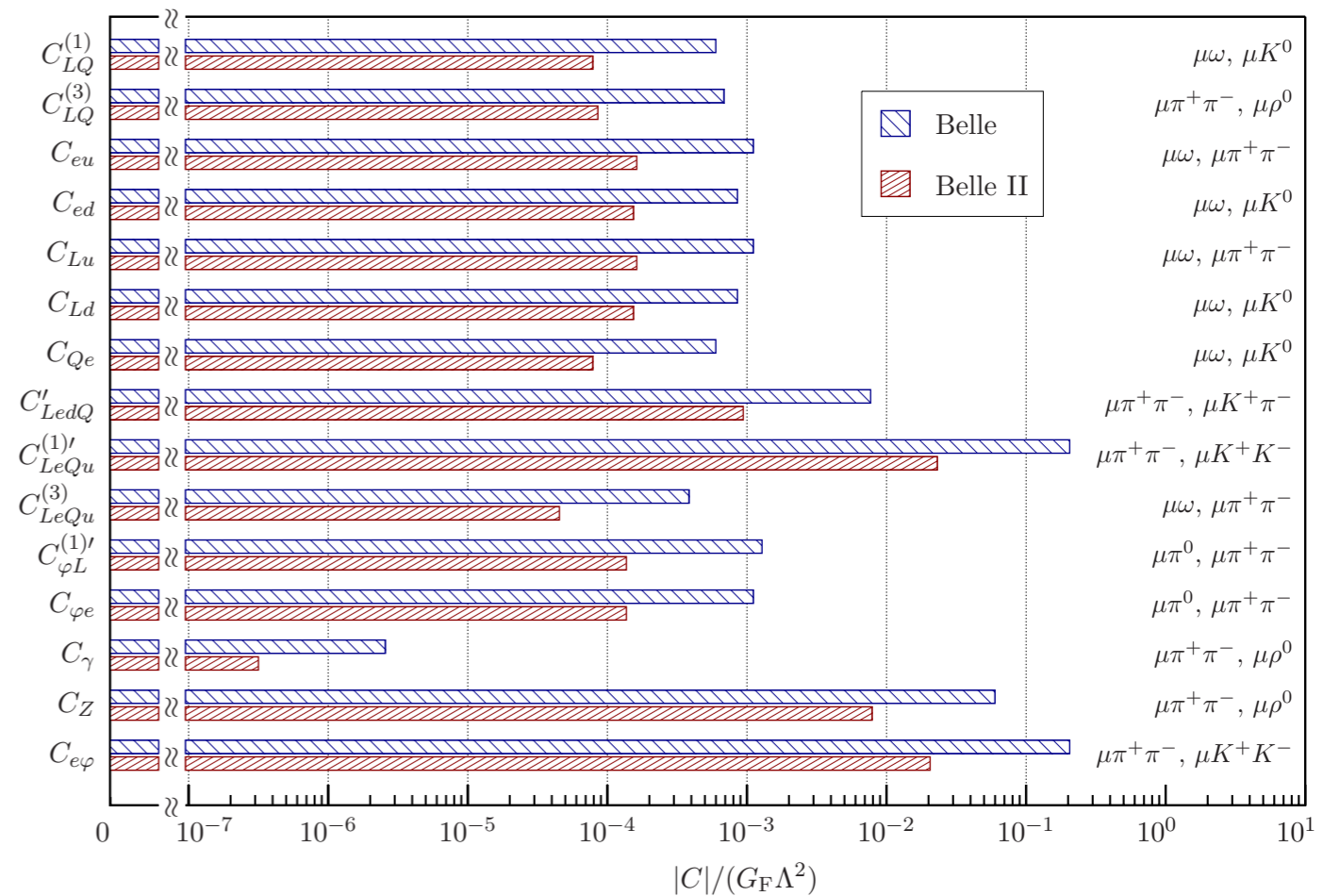

e-Print: [2203.14919 \[hep-ph\]](https://arxiv.org/abs/2203.14919)

Summary and outlook

$\tau^- \rightarrow$	Observed Limits			Expected Limits		
	Experiment	Luminosity	UL (obs)	Experiment	Luminosity	UL (exp)
$\mu^- \gamma$	Belle [93]	988 fb ⁻¹	4.2 × 10 ⁻⁸	Belle II [54]	50 ab ⁻¹	6.9 × 10 ⁻⁹
	BaBar [83]	516 fb ⁻¹	4.4 × 10 ⁻⁸	STCF [74]	1 ab ⁻¹	1.8 × 10 ⁻⁸
				FCC-ee [87, 91]	150 ab ⁻¹	$\mathcal{O}(10^{-9})$
$\mu^- \mu^+ \mu^-$	Belle [102]	782 fb ⁻¹	2.1 × 10 ⁻⁸	Belle II [54]	50 ab ⁻¹	3.6 × 10 ⁻¹⁰
	BaBar [103]	468 fb ⁻¹	3.3 × 10 ⁻⁸	LHCb [76]	300 fb ⁻¹	$\mathcal{O}(10^{-9})$
	LHCb [61]	3 fb ⁻¹	4.6 × 10 ⁻⁸	CMS [77]	3 ab ⁻¹	3.7 × 10 ⁻⁹
	CMS [67]	33 fb ⁻¹	8.0 × 10 ⁻⁸	ATLAS [78]	3 ab ⁻¹	1.0 × 10 ⁻⁹
	ATLAS [68]	20 fb ⁻¹	3.8 × 10 ⁻⁷	STCF [74]	1 ab ⁻¹	1.4 × 10 ⁻⁹
				FCC-ee [87, 91]	150 ab ⁻¹	$\mathcal{O}(10^{-10})$

- **Observation of LFV in the charged lepton sector would completely change our understanding of physics and herald a new period of discoveries in particle physics. Synergies between different experiments compliment discovery potential/confirmation.**
- **Now is a very interesting era in the searches for LFV in decays of the τ lepton, as the current limits will improve by an order of magnitude down to a few parts in 10^{-10} to 10^{-9} at the Belle II experiment. Polarized beams can further improve the sensitivity.**
- **Similar sensitivities will be probed at ATLAS, CMS & LHCb with high luminosity upgrade.**
- **Proposed experiments at STCF, EIC & FCC-ee will continue searches for LFV in the tau sector, also with the possibility of beam polarization.**