



X, Y, Z Search at Belle II

12.03.2018 | Elisabetta Prencipe on behalf of the Belle II Collaboration

IX International Workshop on Charm Physics,
19-15 March 2018 (Novosibirsk, Russia)



Outline



- Introduction
- Motivation
 - how can we improve the Belle achievements?
 - open questions
 - possible interpretation
 - new and unique opportunities at Belle II
- The Belle II experiment – Phase II first collisions
- Perspectives in search for exotics at Belle II
 - Charmonium
 - Bottomonium
- Summary

Introduction

- Gell-Mann Zweig idea: **Constituent Quark Model (CQM)**.
Still valid for half century → it classifies all known hadrons
- **QCD-motivated models** predict the existence of hadrons with more complex structures than simple qq (mesons) or qqq (baryons) → the so-called XYZ “*charmonium*”-like states
- **Lot of experimental effort to prove the existence of XYZ!**
- No unambiguous evidence for hadrons with *non-CQM-like* structures has been found
- New possibilities, started with the observation of the X(3872):
 - **tetraquarks** - **molecular states** - **pentaquarks** - **glueballs**
 - **hybrids** - **hadrocharmonium** - **hexaquarks** - **cusps...**
- Evidence that there is more than *mesons* and *baryons*!

Substantial contribution from Belle (1999-2010) into the field

Quark Bound States



Lifetime:
 $< 10^{-8}$ s

Meson



Lifetime:
 $> 10^{30}$ y (proton)
 ~ 10 min (neutron)
 $< 10^{-10}$ s (others)

Baryon

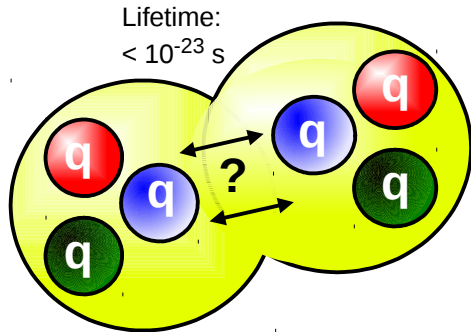

Lifetime:
 $< 10^{-23}$ s

Di-baryon

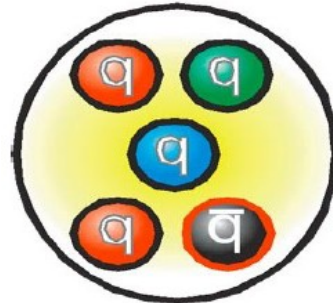

Lifetime:
 $< 10^{-20}$ s

Pentaquark



Hybrid meson



Glueball



Lifetime:
 $< 10^{-23}$ s

Tetraquark

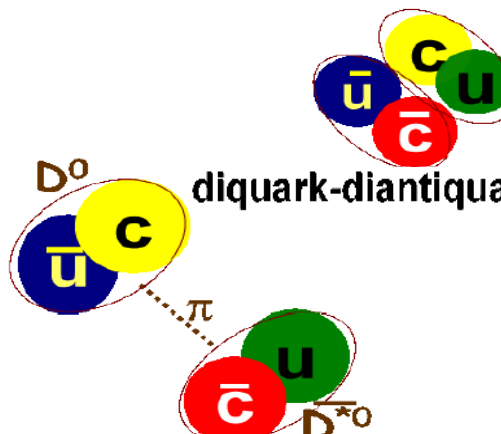

diquark-diantiquark

$D^0 - \bar{D}^{*0}$ "molecule"

...and superposition of different states: $c_1 |\bar{q}q\rangle + c_2 |\bar{q}q\bar{q}q\rangle + \dots$

Charmonium(-like) Spectrum

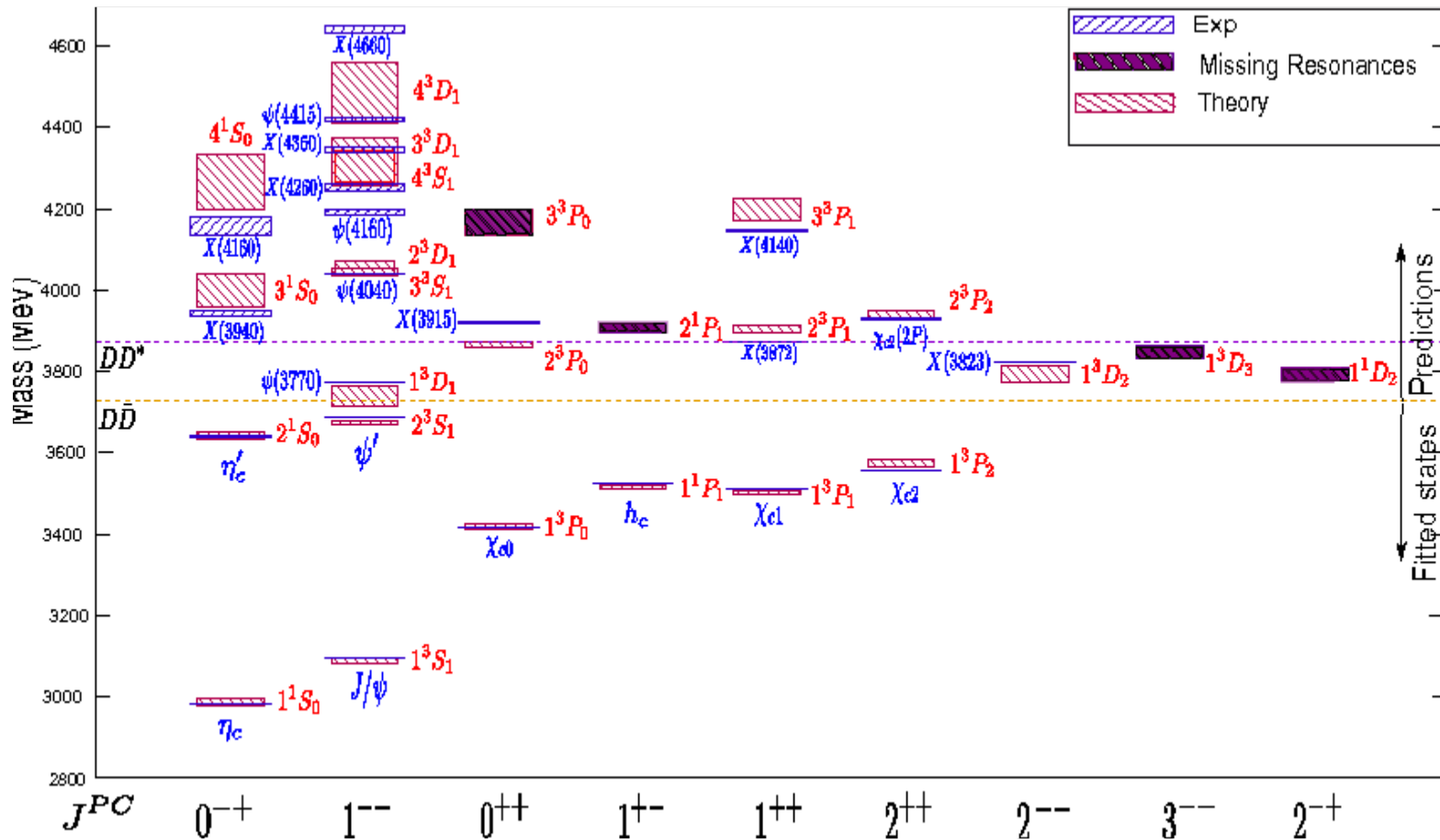

- Overall agreement experiments-theory so far: precision $\sim 2-3$ MeV; but since 2003 several new entries!

- BaBar + Belle:
1.5 ab^{-1} integrated luminosity - triumph in the history of B-factories!

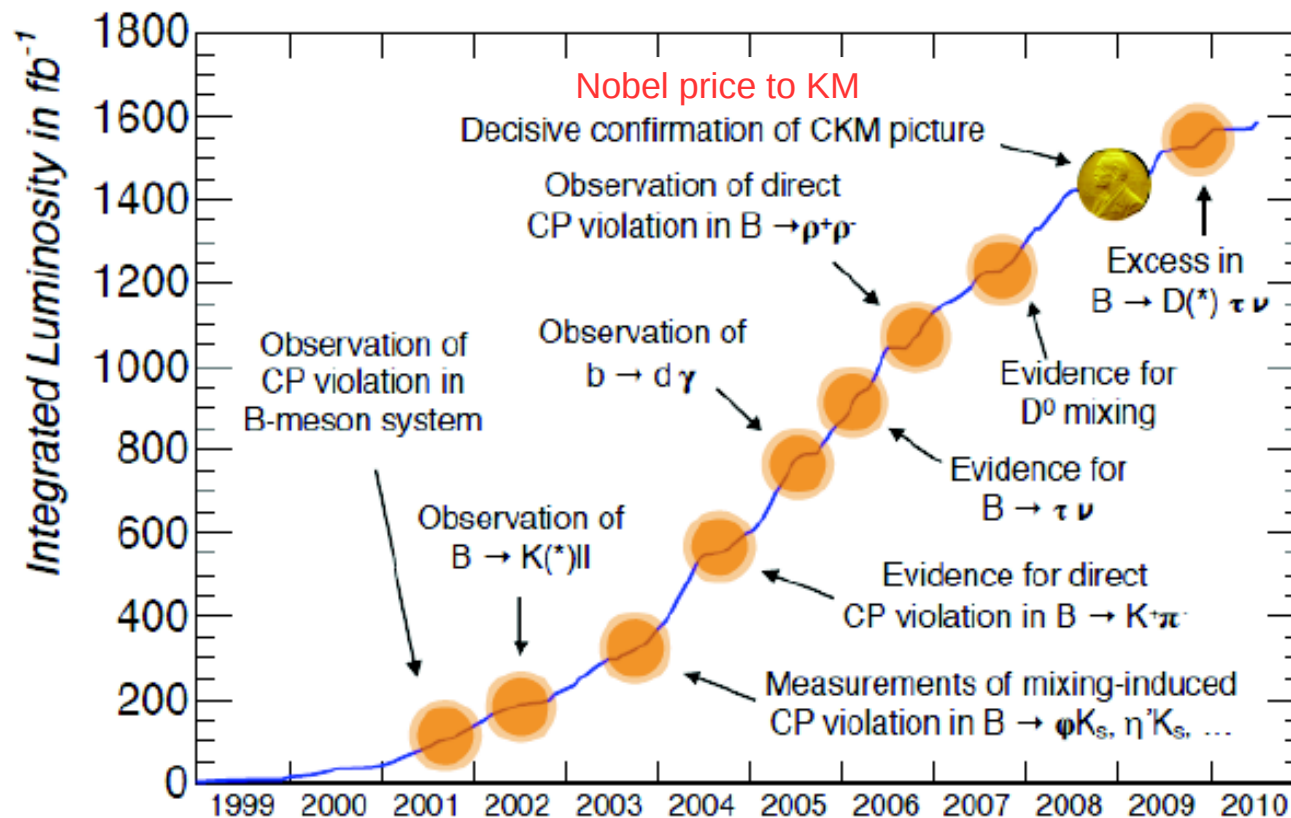

- Not only B-factory, but $\bar{c}c$ -factory with so high luminosity
- Still statistics limitation in spectroscopy for rare processes ($\text{BR} < 10^{-5}$)
- Upgrade needed!

← Belle detector

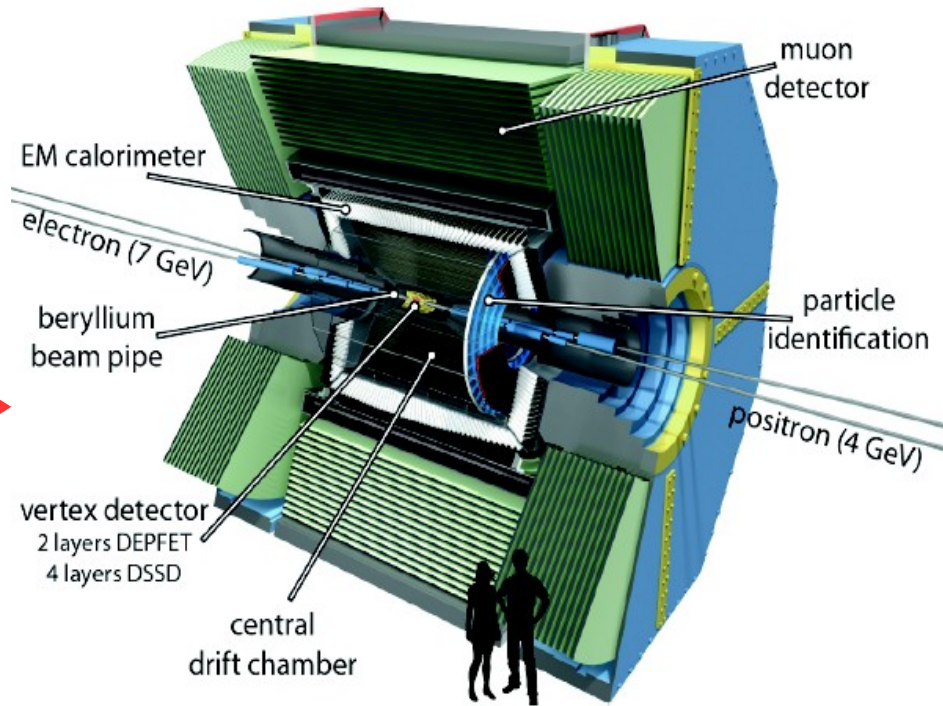
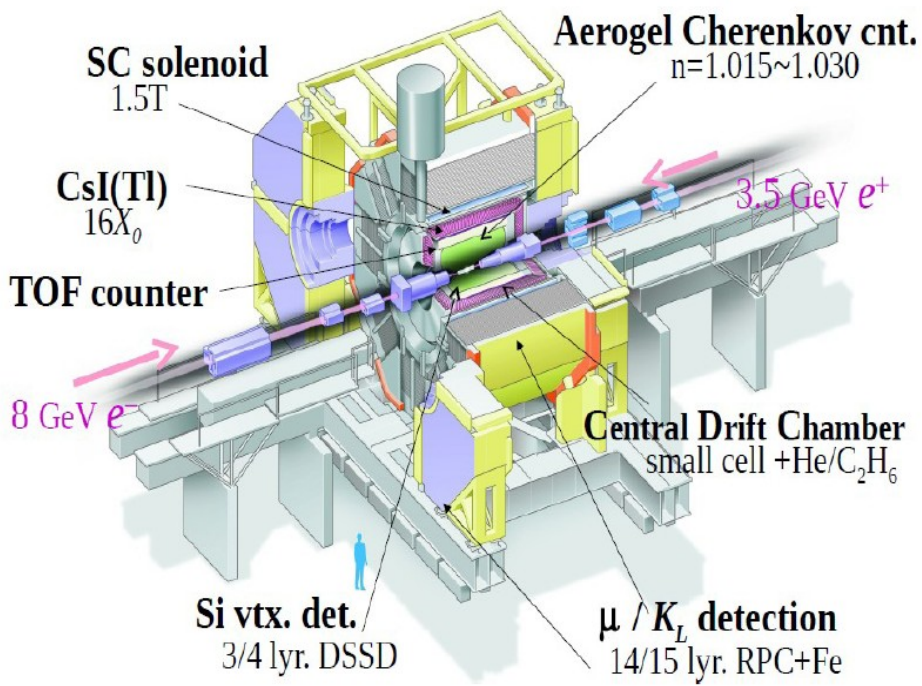

Belle II detector →
25 countries,
750 physicists



From Belle to Belle II

What has been changed?

- **PXD**, **vertex resolution** in z direction (beam direction) will be factor 2 better than before:
50 μm (Belle) \rightarrow 25 μm (Belle II)
- **TOP**: no TOF (time-of-flight) detector anymore, but TOP (time-of-propagation) will do the timing of the Cerenkov light. Time resolution \sim 50 ps. TOP detector surface is polished to nanometer precision for total reflection of Cerenkov light
- **KLM**: inner 2 layers of barrel + all layers in the endcap replaced by scintillators, because of large background
- **ECL** readout electronics exchanged, fast **FADC** sampling for identify pile-up of pulses
- Huge gain in **luminosity** in Belle II compared to Belle: factor **x40**. How?
 - factor 2 by beam current: 1.64/1.19 A (Belle) \rightarrow 3.6/2.6 A for $e^+(e^-)$ beam in Belle II
 - factor 20 by "**nano-beam**" principle (collision point in vertical direction will be only 59 nm)

β_y^* function: 5.9 mm (Belle), 0.27 mm (Belle II)

$$\beta_y(z) = \beta_y^* \left(1 + \frac{(z - Z_0)^2}{\beta_y^{*2}} \right)$$

$$\sigma_y(z) \propto \sqrt{\beta_y(z)}$$

Y Family - Summary

Contribution from Belle

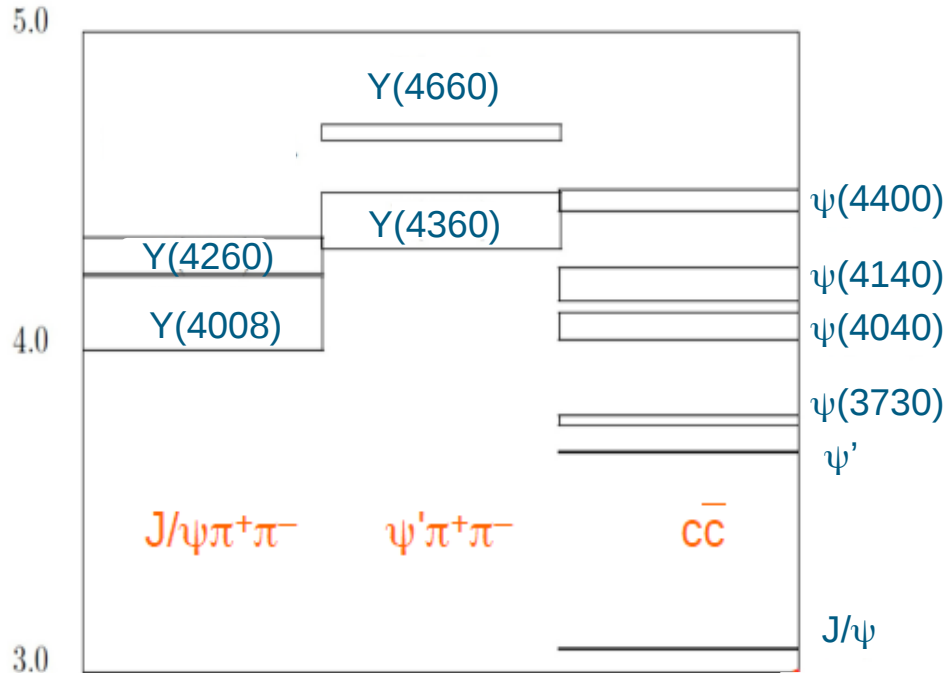

	Mass (MeV/c ²)	Width (MeV)
Y(4008)	$4008 \pm 40^{+114}_{-28}$	$226 \pm 44 \pm 87$
Y(4260)	$4258.6 \pm 8.3 \pm 12.1$	$1134.1 \pm 16.4 \pm 5.5$
Y(4360)	$4361 \pm 9 \pm 9$	$74 \pm 15 \pm 10$
Y(4660)	$4664 \pm 11 \pm 5$	$48 \pm 15 \pm 3$

- ISR studies: **unique** at B factories
- Clear signature: $J^{PC} = 1^{--}$
- No mixing \Rightarrow surprising!
- Limited statistics at B-factories for such rare events: need more data!

Z Charged States

Main achievements at Belle

$B^0 \rightarrow K^- \pi^+ \psi'$

Update

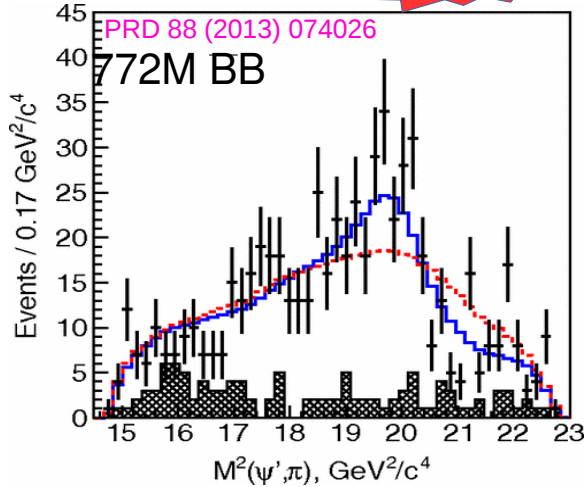

$$M = 4485^{+22}_{-11} \text{ MeV}/c^2$$

$$\Gamma = 200^{+21}_{-46} \text{ MeV}$$

6.4σ , $J^P = 1^+$

First observation: Belle,
PRL 100 (2008) 142001;
Confirmed by LHCb:
PRD 92(2015) 112009

$e^+e^- \rightarrow \pi^+ \pi^- J/\psi$, $Z_c(3900) \rightarrow \pi J/\psi$

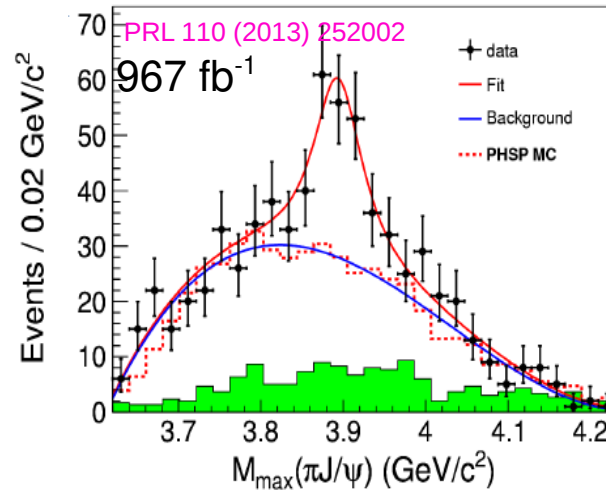

$$M = 3894.5 \pm 6.6 \pm 4.5 \text{ MeV}/c^2$$

$$\Gamma = 63 \pm 24 \pm 26 \text{ MeV}$$

$>5.2\sigma$

BESIII confirmation/following
PRL 110 (2013) 252001

$e^+e^- \rightarrow \pi^+ \pi^- \psi'$, $Z_c(4050) \rightarrow \pi \psi'$

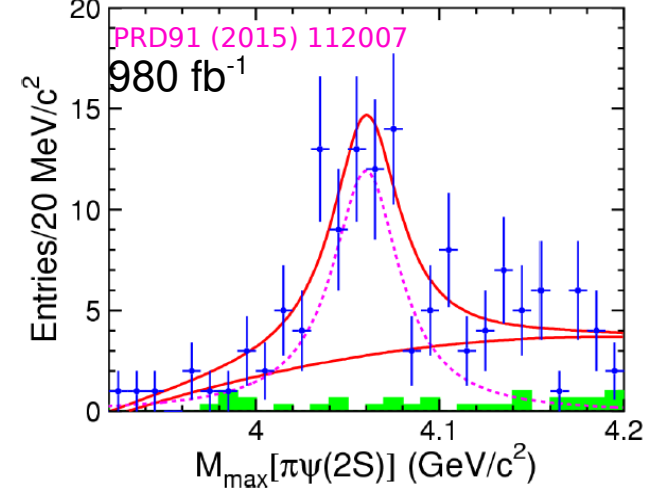

$$M = 4054 \pm 3 \pm 1 \text{ MeV}/c^2$$

$$\Gamma = 45 \pm 11 \pm 6 \text{ MeV}$$

$>3.5\sigma$

Two different classes of Z states?

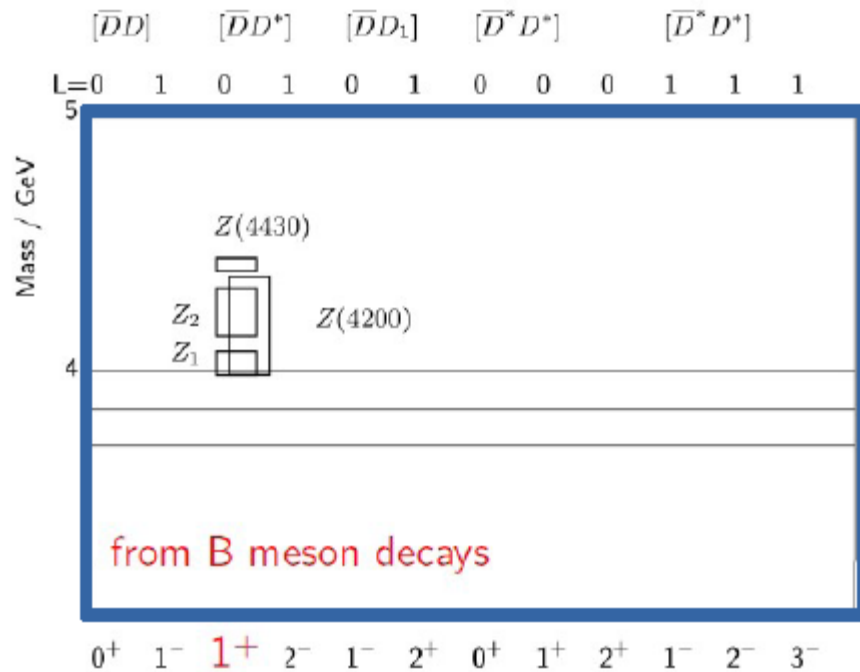

- large widths
- not connected to thresholds?

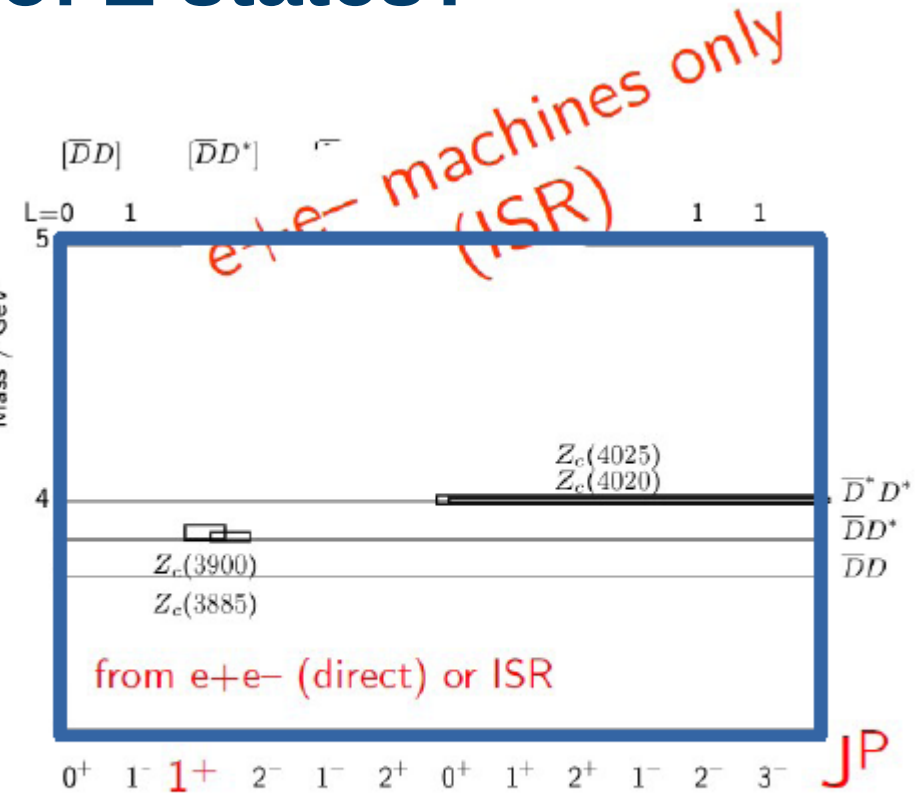

- narrow widths
- near thresholds

- Belle II is in a **unique** position to look for both Z types:
 - through B decays (LHCb, no BES III)
 - threshold state (BES III, no LHCb)

Charmonium in ISR: Perspectives at Belle II

- Line shape of the Y(4260)
- Strange partner of Z(3900) in KKJ/ψ
- Cross sections of exclusive $(c\bar{c}) + \text{Hadrons}$

Golden Channels	$E_{c.m.}$ (GeV)	Statistical error (%)	Related XYZ states
$\pi^+\pi^- J/\psi$	4.23	7.5 (3.0)	Y(4008), Y(4260), $Z_c(3900)$
$\pi^+\pi^- \psi(2S)$	4.36	12 (5.0)	Y(4260), Y(4360), Y(4660), $Z_c(4050)$
$K^+K^- J/\psi$	4.53	15 (6.5)	Z_{cs}
$\pi^+\pi^- h_c$	4.23	15 (6.5)	Y(4220), Y(4390), $Z_c(4020)$, $Z_c(4025)$
$\omega\chi_{c0}$	4.23	35 (15)	Y(4220)

10 ab^{-1} 50 ab^{-1}

XYZ Expectations at Belle II

- Yield of $X(3872) \rightarrow J/\psi \pi^+ \pi^-$ in 2020 will be about Belle yield of $\psi' \rightarrow J/\psi \pi^+ \pi^-$
- Radiative decay $X(3872) \rightarrow J/\psi \gamma$: expected yield $N \approx 350$ in 2020 (scaled from Belle, Phys. Rev. Lett. 107(2011)091803), a factor **x2** more than $X(3872) \rightarrow J/\psi \pi^+ \pi^-$ at Belle, full dataset.
- The width of the $X(3872)$ could be measured with a systematic error of **± 0.11 MeV** in radiative X decay
 - **monoenergetic** photon provides 4-constraint fit ($\Delta E/E \sim 2\%$)
 - systematic error on width may be **~ 110 keV**
- Search for exotics at $D^* D^*$ threshold (better slow pion detection at Belle II)
 - slow pions reconstruction efficiency $> 60\%$ (L. Koch, Master Thesis 2016)

State	Production and Decay	N
$X(3872)$	$B \rightarrow K X(3872)$, $X(3872) \rightarrow J/\psi \pi^+ \pi^-$	$\simeq 14400$
$Y(4260)$	ISR, $Y(4260) \rightarrow J/\psi \pi^+ \pi^-$	$\simeq 29600$
$Z(4430)$	$B \rightarrow K^\mp Z(4430)$, $Z(4430) \rightarrow J/\psi \pi^\pm$	$\simeq 10200$

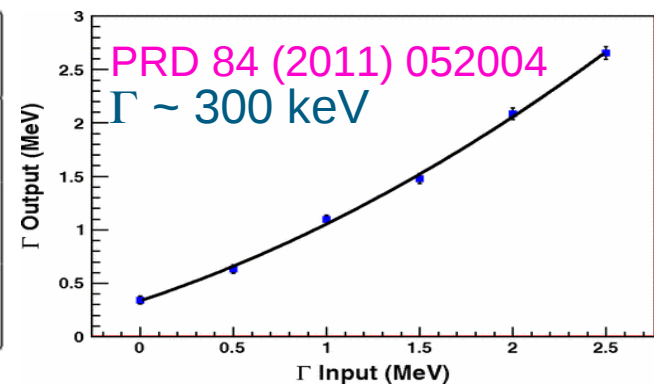

Expectation with 50ab^{-1} data at Belle II

Expected Luminosity at Belle II

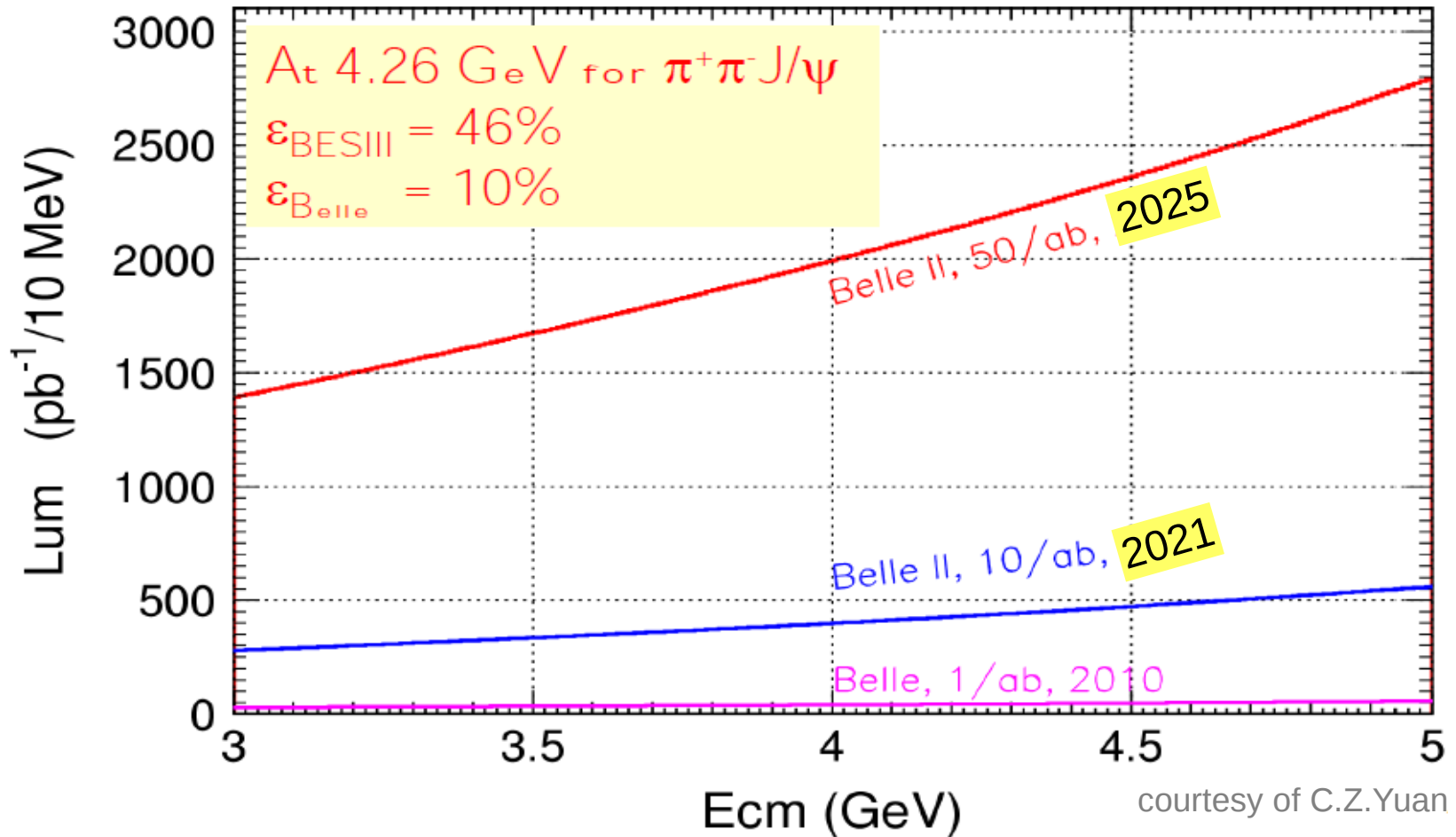

Why Bottomonium at Belle II?



- Bottomonium spectrum is significantly different from charmonium spectrum
 - n=3 state (3P) is below the threshold
 - L=2 state (1D) is below the threshold
- Z_b states were only found so far in $\Upsilon(5S)$ decays
- SuperKEKB can reach $E_{\text{c.m.}} \approx 11$ GeV
 - $\Rightarrow \Upsilon(6S)$ running possible – **unique possibility!**
- With the high luminosity, for the 1st time study **radiative transitions between bottomonia states possible** (suppressed by 1/137). Marginal statistics so far at Belle, big advantage at Belle II

Main Achievements in Bottomonium at Belle



Summary from PRL 116 (2016) 212001

Branching Ratios

Channel	Fraction, %	
	$Z_b(10610)$	$Z_b(10650)$
$\Upsilon(1S)\pi^+$	$0.54^{+0.16+0.11}_{-0.13-0.08}$	$0.17^{+0.07+0.03}_{-0.06-0.02}$
$\Upsilon(2S)\pi^+$	$3.62^{+0.76+0.79}_{-0.59-0.53}$	$1.39^{+0.48+0.34}_{-0.38-0.23}$
$\Upsilon(3S)\pi^+$	$2.15^{+0.55+0.60}_{-0.42-0.43}$	$1.63^{+0.53+0.39}_{-0.42-0.28}$
$h_b(1P)\pi^+$	$3.45^{+0.87+0.86}_{-0.71-0.63}$	$8.41^{+2.43+1.49}_{-2.12-1.06}$
$h_b(2P)\pi^+$	$4.67^{+1.24+1.18}_{-1.00-0.89}$	$14.7^{+3.2+2.8}_{-2.8-2.3}$
$B^+\bar{B}^{*0} + \bar{B}^0B^{*+}$	$85.6^{+1.5+1.5}_{-2.0-2.1}$...
$B^{*+}\bar{B}^{*0}$...	$73.7^{+3.4+2.7}_{-4.4-3.5}$

Expectations on Z_b states at Belle II

- If Z_b is a loosely bound state, several new molecular states should appear

$\Upsilon(6S)$ and $\Upsilon(5S)$: conventional state search

- Belle II goals:
 - search for new, predicted, resonances
 - use both, single transitions and double cascade
 - fill the remaining spectrum to measure the effect of the coupled channel contribution

$\Upsilon(6S)$ and $\Upsilon(5S)$: new exotics search

- Belle II goals:
 - $\Upsilon(6S)$: 100 fb^{-1} exploratory run
 - $\Upsilon(5S)$: 1 ab^{-1} high statistics run

$\Upsilon(6S)$ and $\Upsilon(5S)$: scan

- Belle II goals:
 - $\Upsilon(6S)$ and $\Upsilon(5S)$ behave differently in $\pi\pi\Upsilon$ and $\pi\pi h$
 → hint of a non- bb nature of $\Upsilon(5S)$?
 - investigate an extra resonance around $10.750 \text{ MeV}/c^2$

Settle the nature of $\Upsilon(5S)$

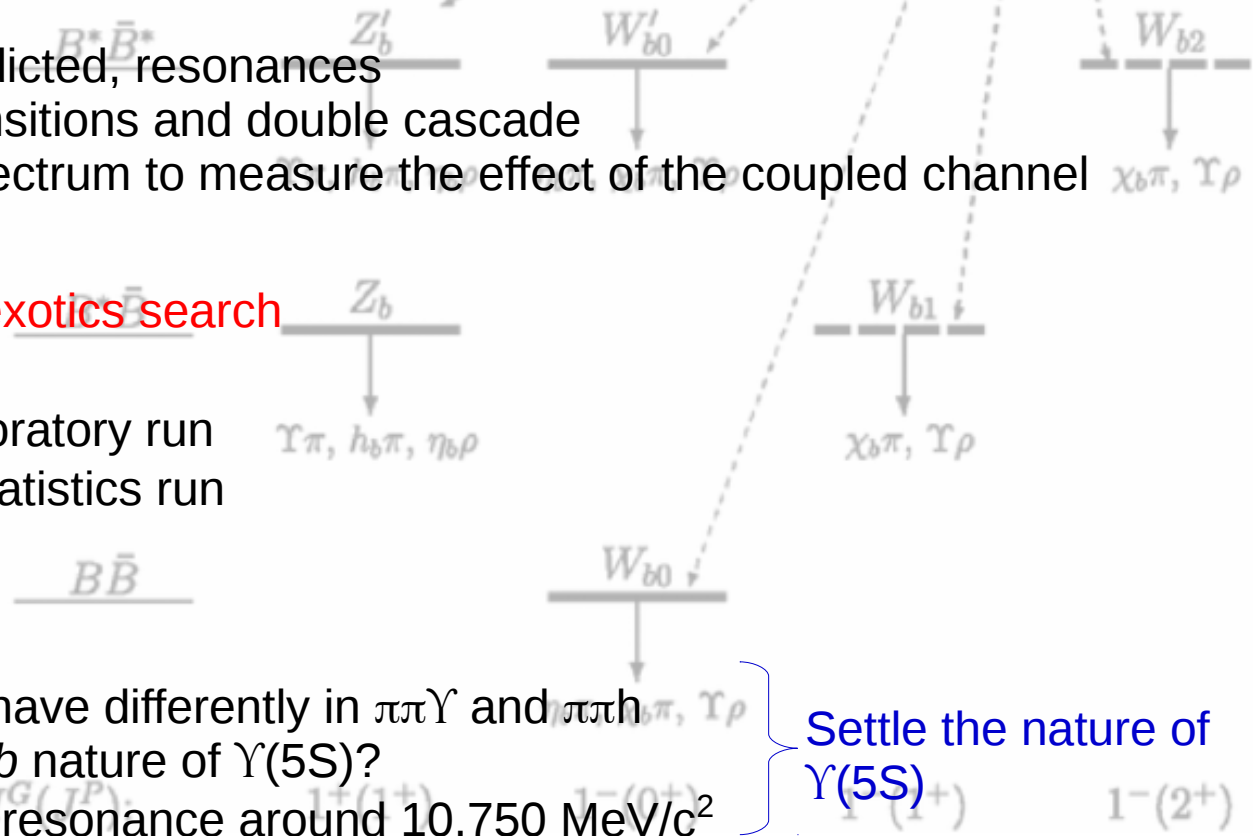

$\Upsilon(3S)$: Opportunities at Belle II

- Exotic states contribute to the hadronic and radiative transitions from narrow quarkonia

→ complimentary approach to the direct search from $\Upsilon(5S)$ and $\Upsilon(6S)$

$\Upsilon(3S)$: exotics in transitions

- Belle II goals:
 - $\Upsilon(3S) \rightarrow \pi\pi\Upsilon(1S, 2S)$ still limited by statistics
 - perform full amplitude analysis
 - search for missing $\pi\pi/\eta$ transitions to constraint further theoretical models
 - study hindered radiative transitions

$\Upsilon(3S)$: charmonia in production

- Belle II goals with 300 fb^{-1} :
 - up to 5x sensitivity in inclusive production from $\Upsilon(3S)$
 - up to 15x in double charmonium
 - inclusive rate of $X(3872)$
 - $D\bar{D}^*$ correlation in $\Upsilon(3S) \rightarrow D\bar{D}^* + \text{hadron}$ to test the nature of the $X(3872)$

$\Upsilon(3S)$: rare χ_b decays

$\Upsilon(3S)$: deuteron production mechanism

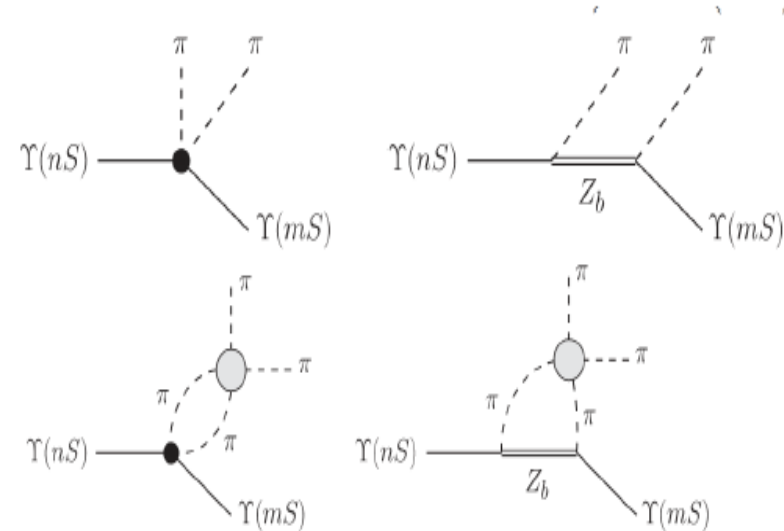

How can Belle II perform these challenging measurements?

- most powerful e+e- collider in the world
- x40 more luminosity than Belle
- high vertex resolution
- excellent tracking performance
- improved slow pion detection

Vertex Pixel Detector (PXD)

VXD consists of 2 layers of DEPFET (Pixel Detector) and 4 layers of double-sided silicon microstrip sensors (Silicon Vertex Detector), assembled over carbon fiber ribs.

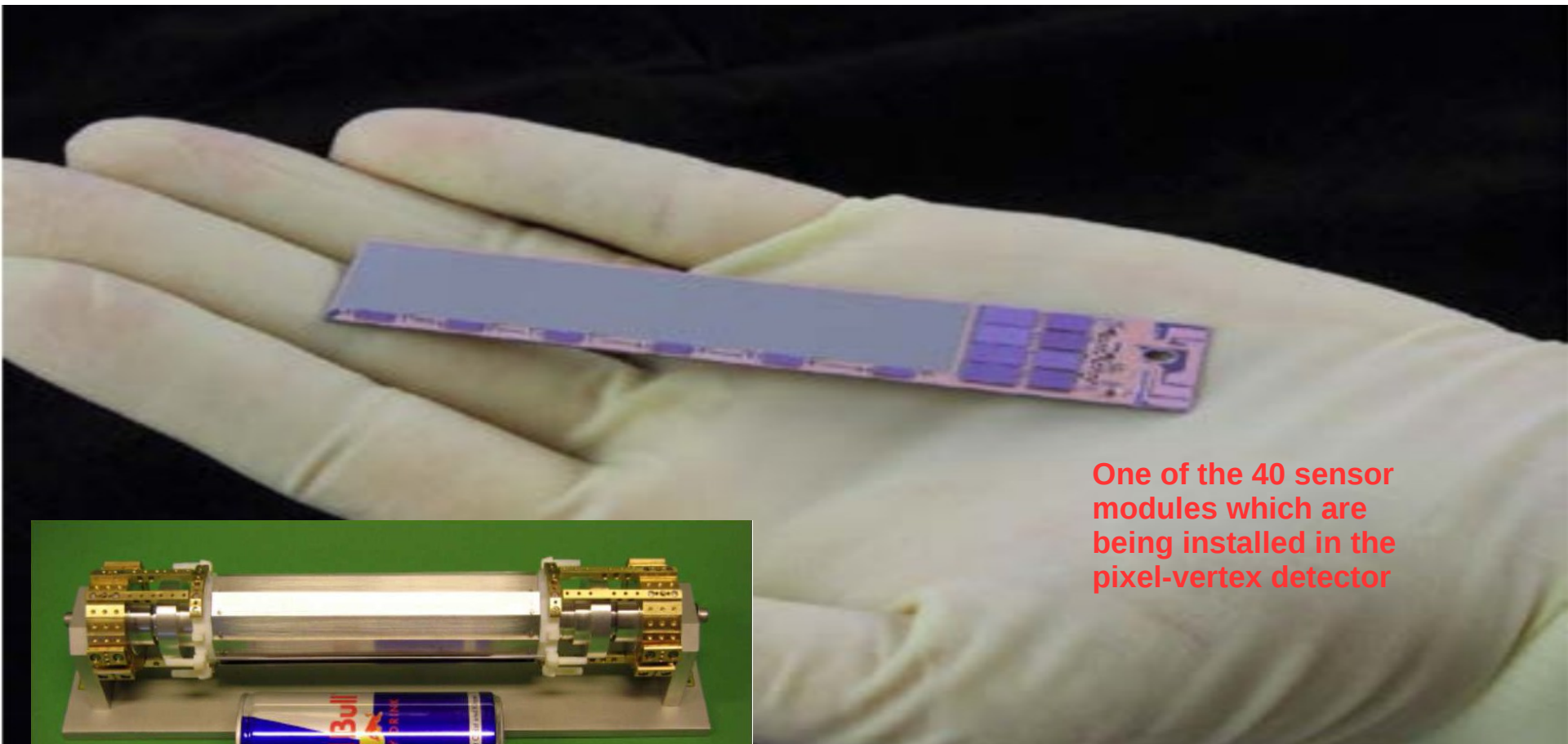

Vertex Pixel Detector (PXD)

VXD consists of 2 layers of DEPFET (Pixel Detector) and 4 layers of double-sided silicon microstrip sensors (Silicon Vertex Detector), assembled over carbon fiber ribs.

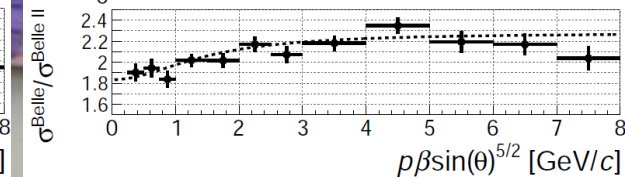
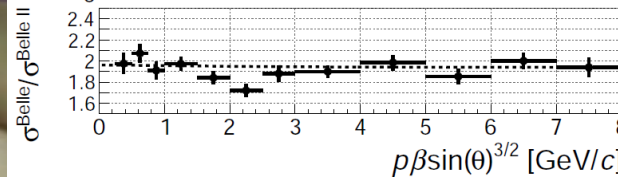
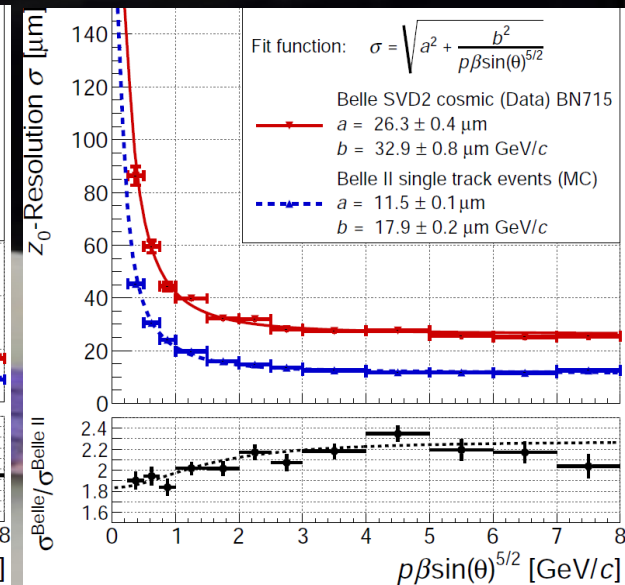
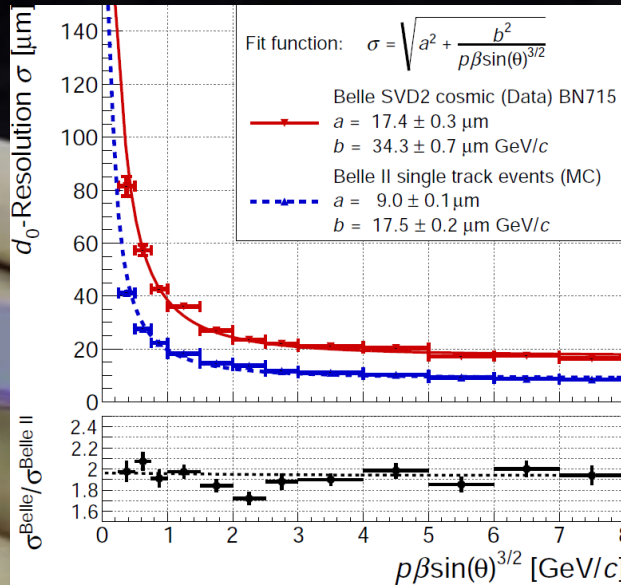
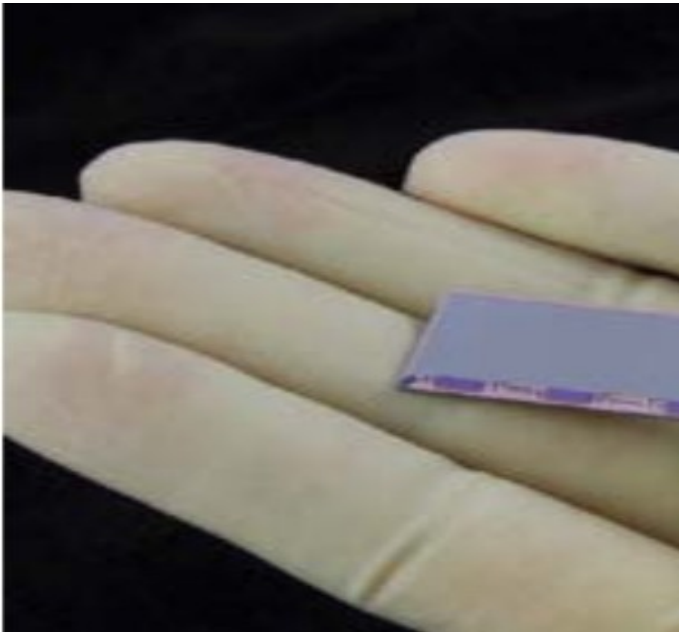

Central Drift Chamber (CDC)

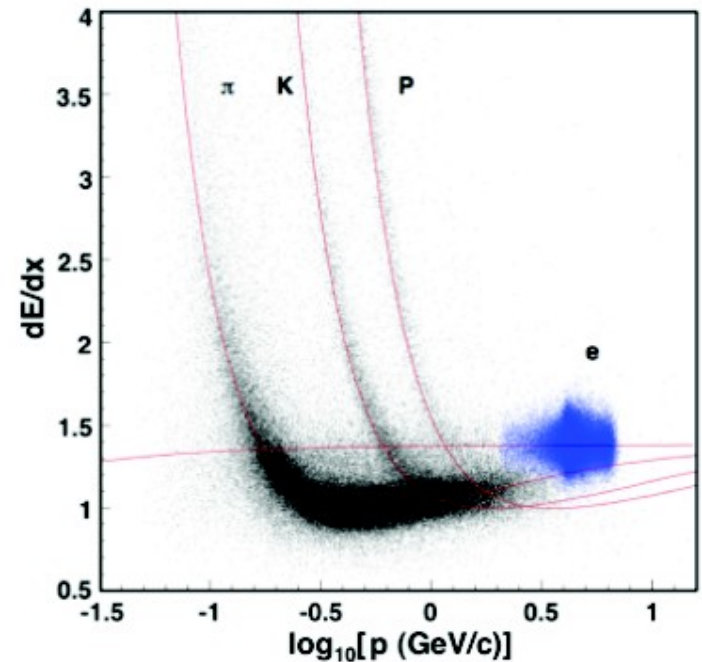
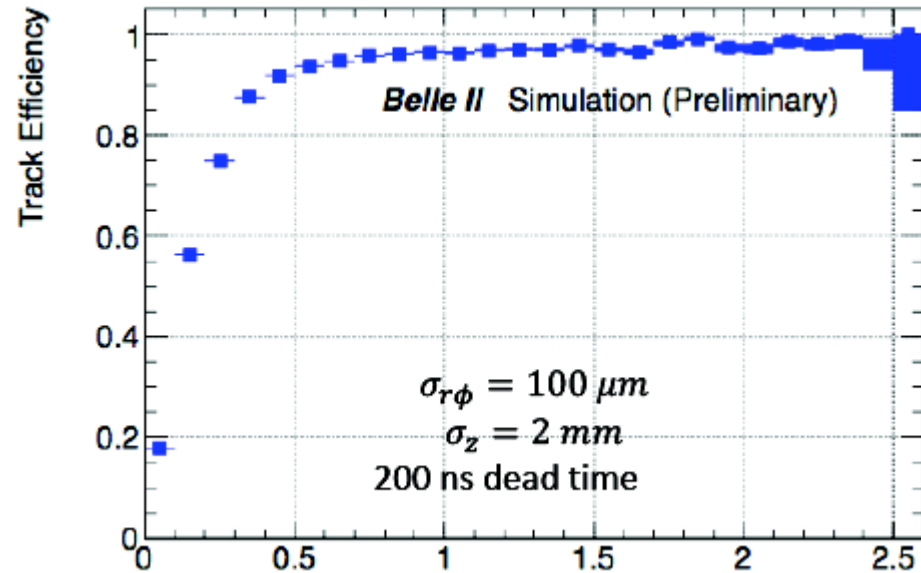
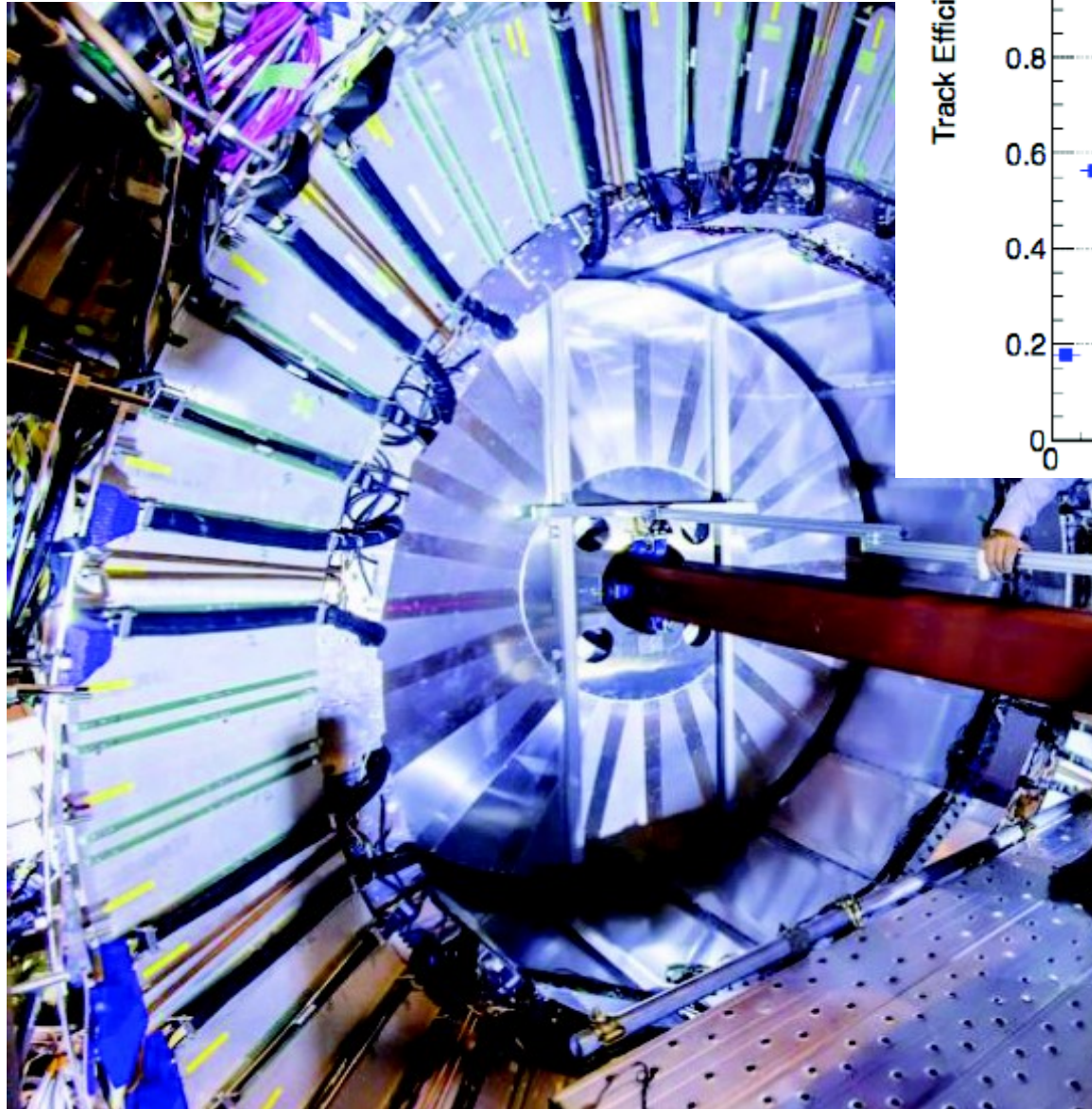

Cerenkov detector, laser in TOP module



Particle Identification

(Time-of-propagation, $t \leq 50$ ps)

Photo: K. Inami (Nagoya)

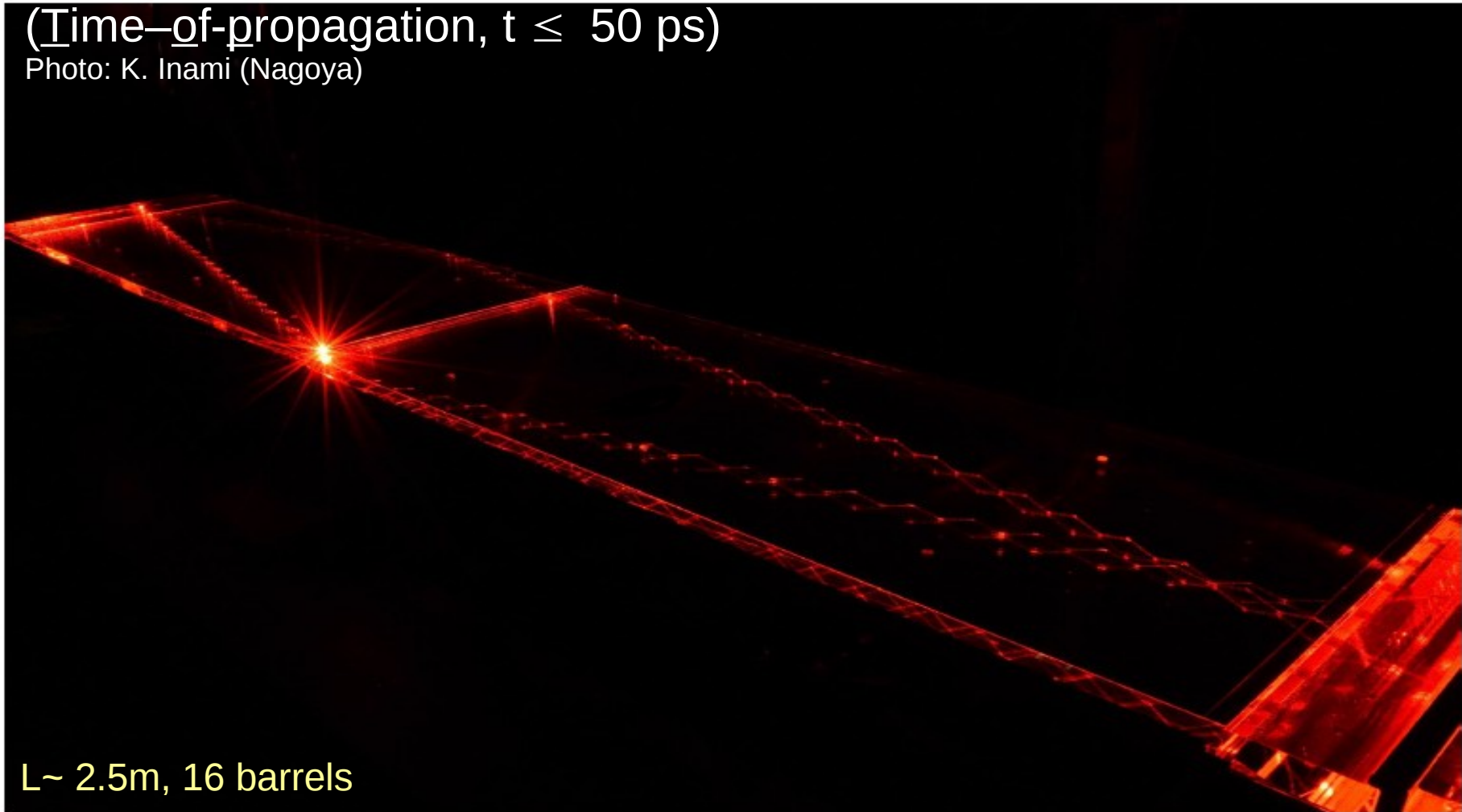

L ~ 2.5m, 16 barrels

MC Study

PID: Efficiency and fake rates

Continuum D^* MC Study

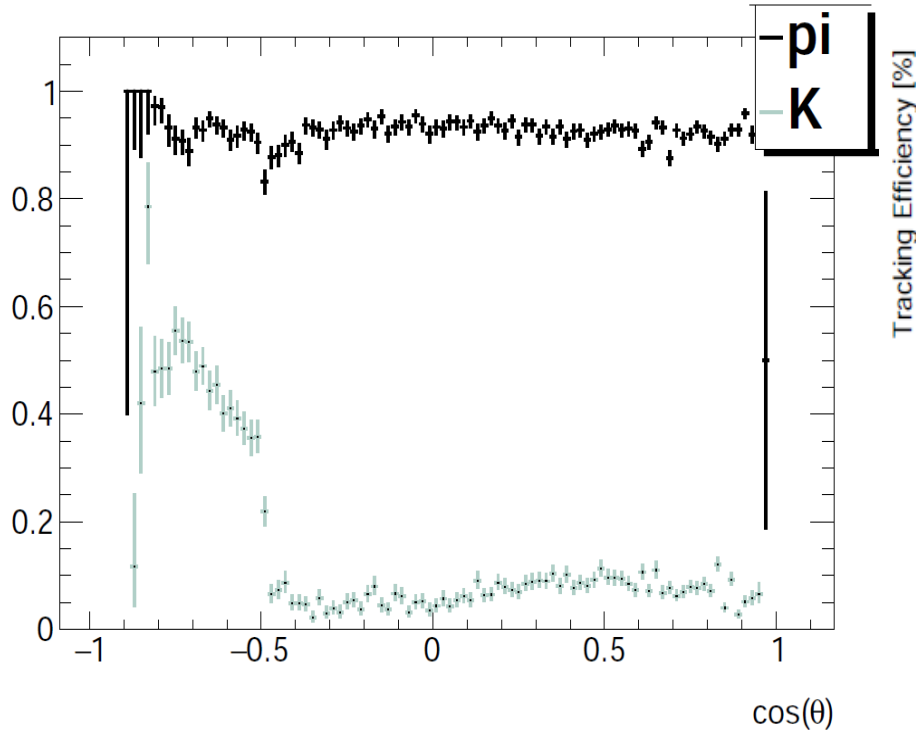

Tracking Efficiency and fake rates

$B^0 \rightarrow \Phi K_S^0$

L. Koch, master thesis 2016

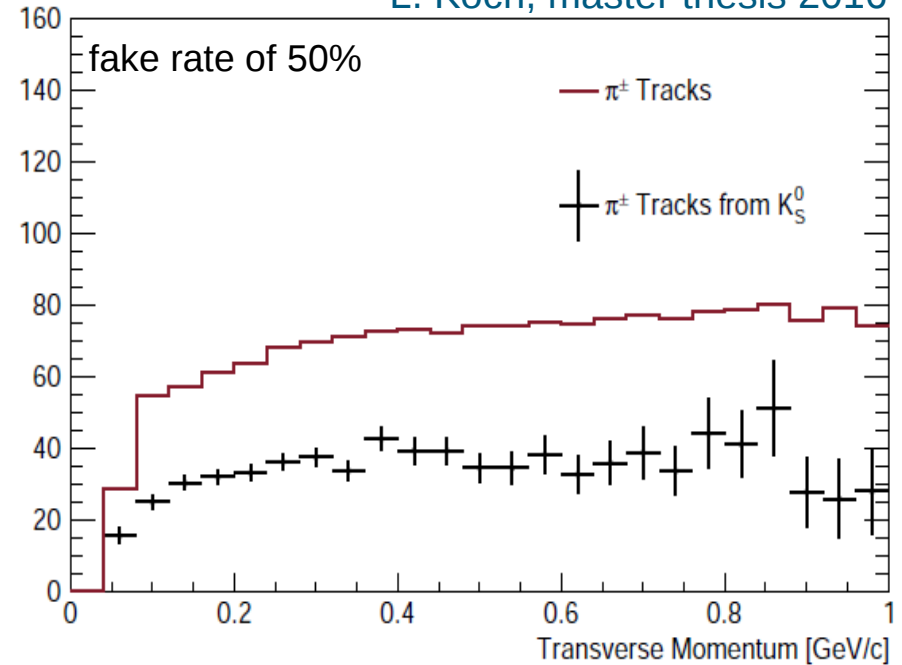

15.01.2018: MILESTONE!

Superconductive magnet systems installed

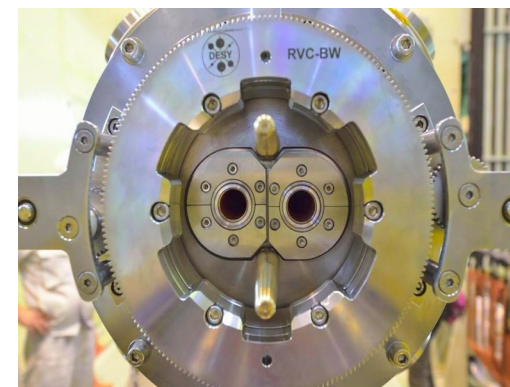
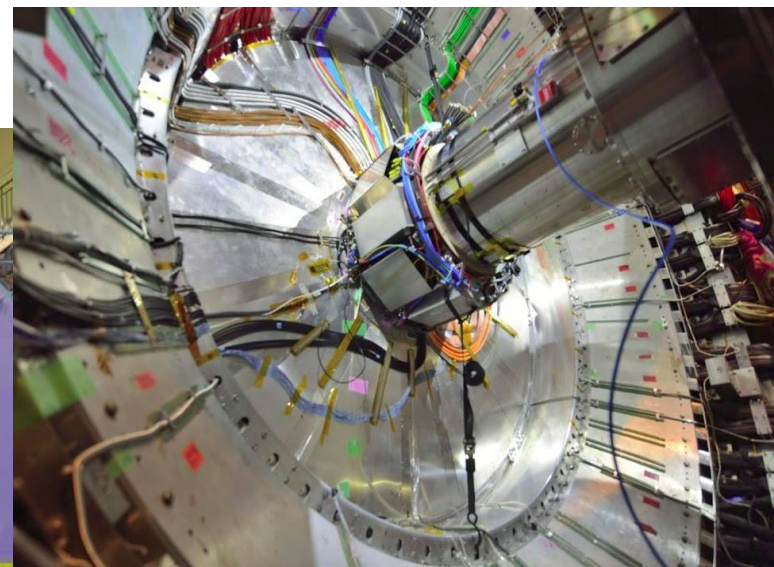
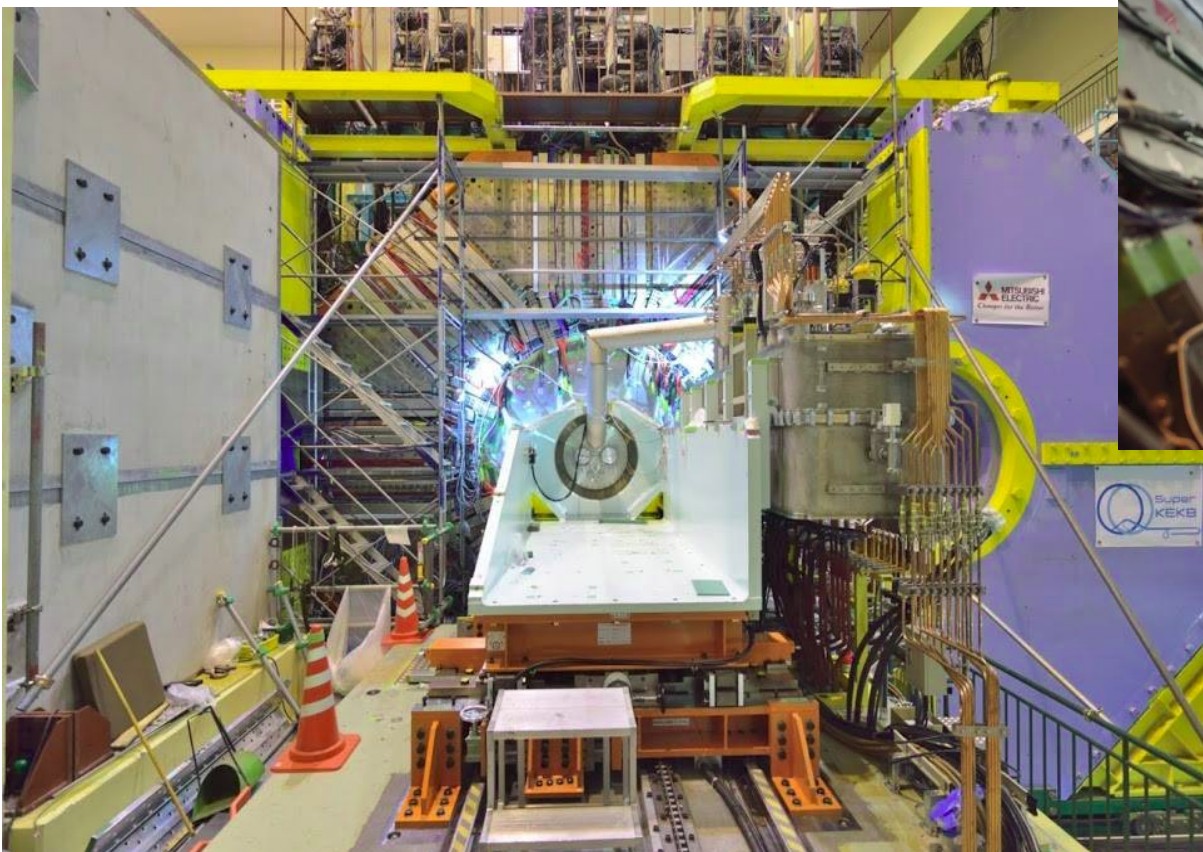

14.02.2018: Phase-II Has Started

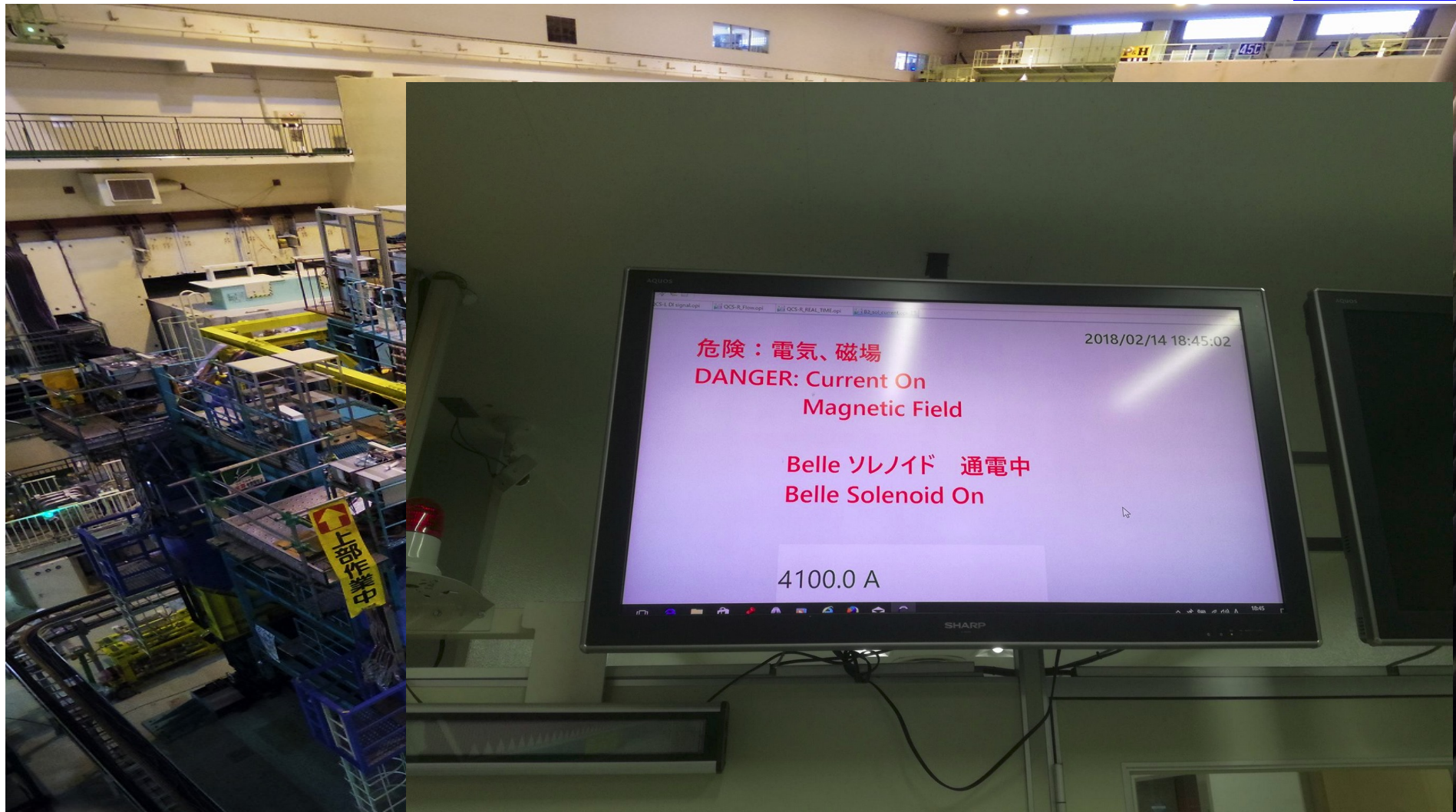

14.02.2018: Phase-II Has Started



18.02.2018 - First Data

Cosmics in the PXD

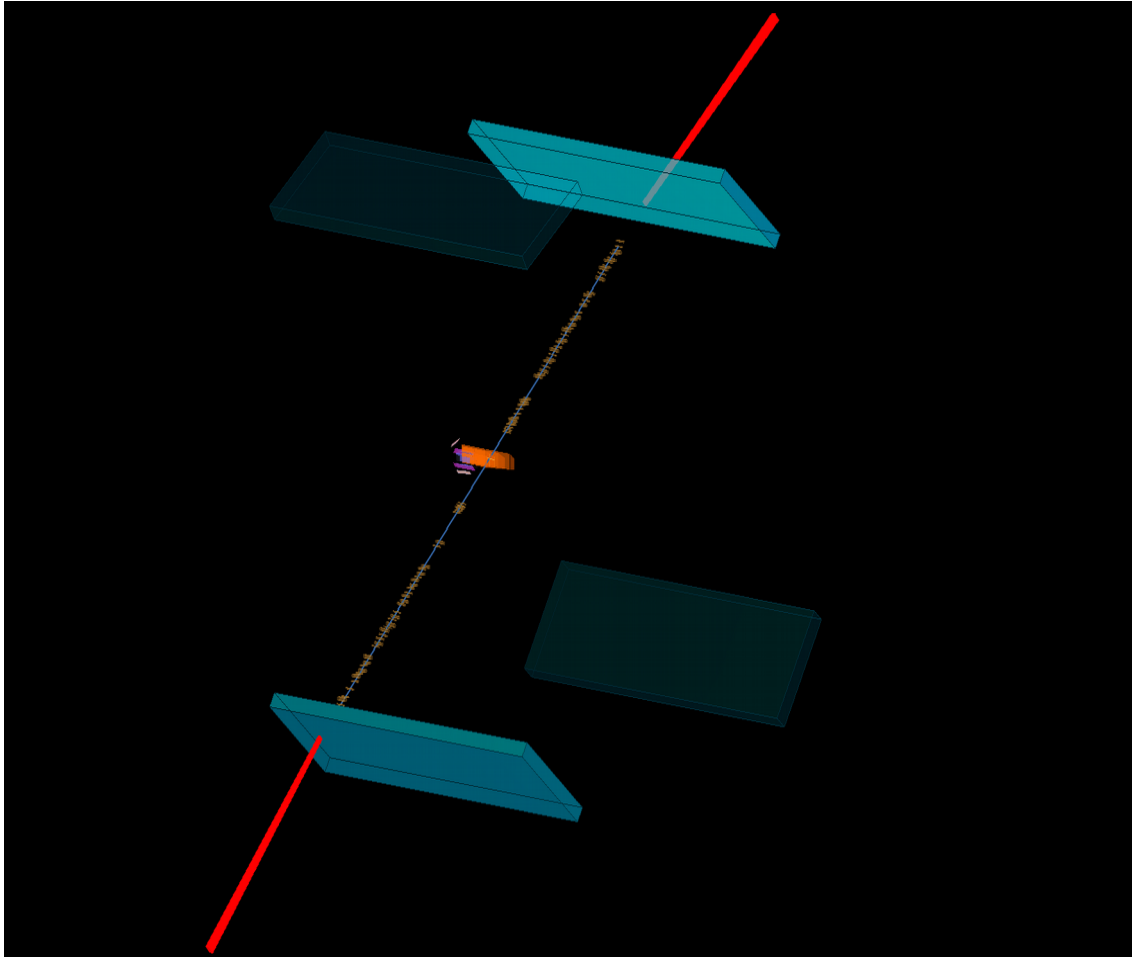

- Two inner sub-detectors right now into the data acquisition system.
- The final Belle II vertex detector with its full *pixelated* silicon detector (PXD) and a double-sided microstrip silicon detector (SVD) is under construction and will be installed later this year.

26.02.2018 – First Data

Cosmics in the ARICH

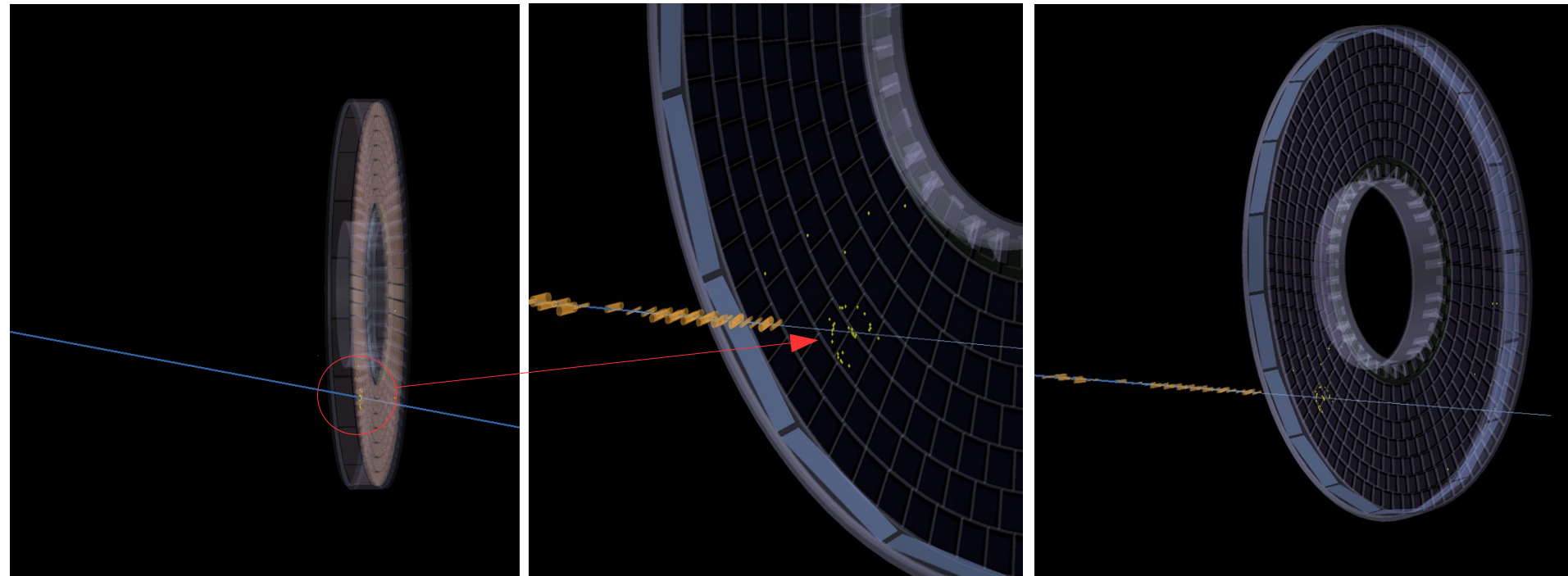

A hadronic event recorded at h. 00:38, **26.04.2018** –
first collision confirmation

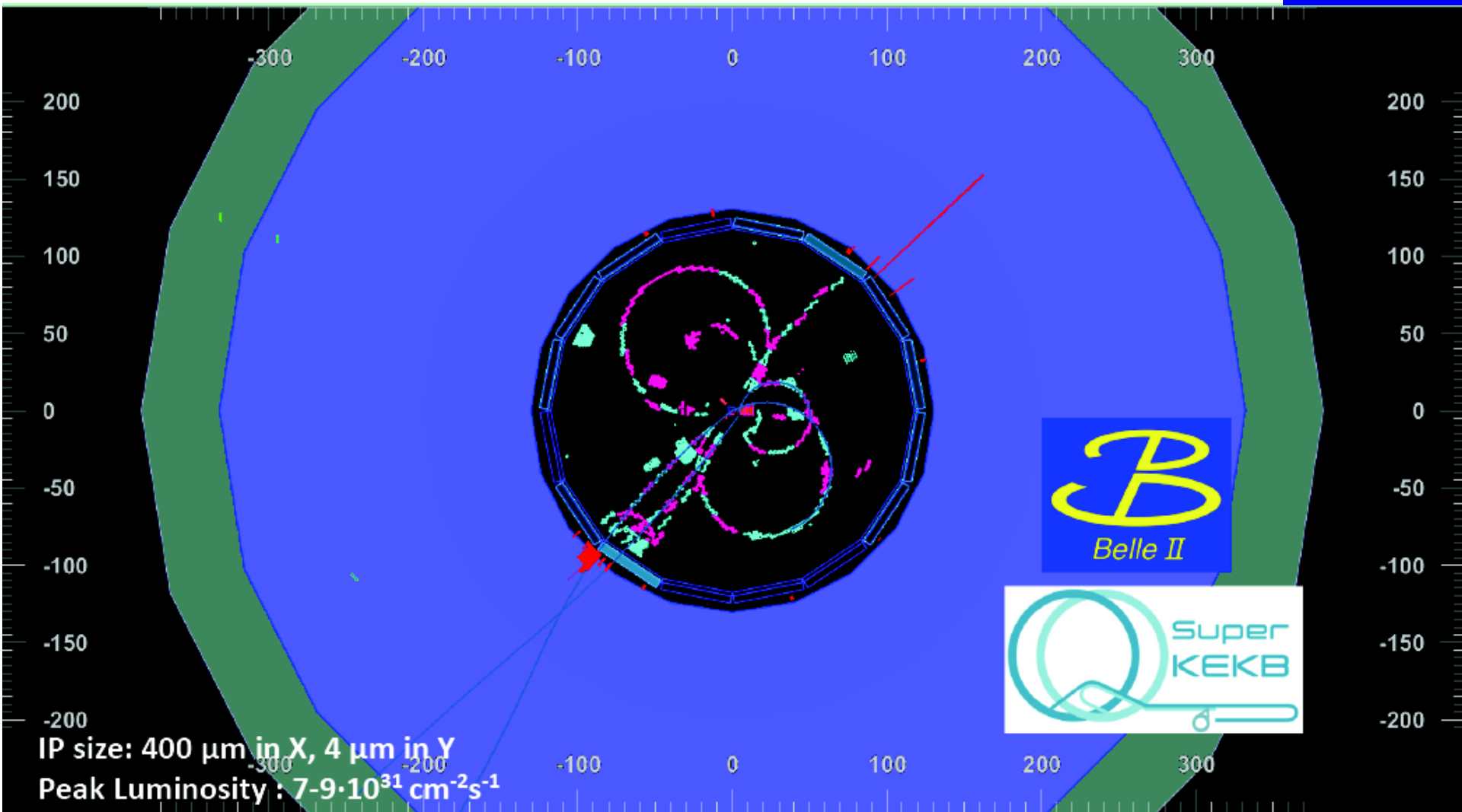

-150 -100 -50 0 50 100 150



Bhabha candidate event
exp3 run126 ev73
Apr. 26, 2018

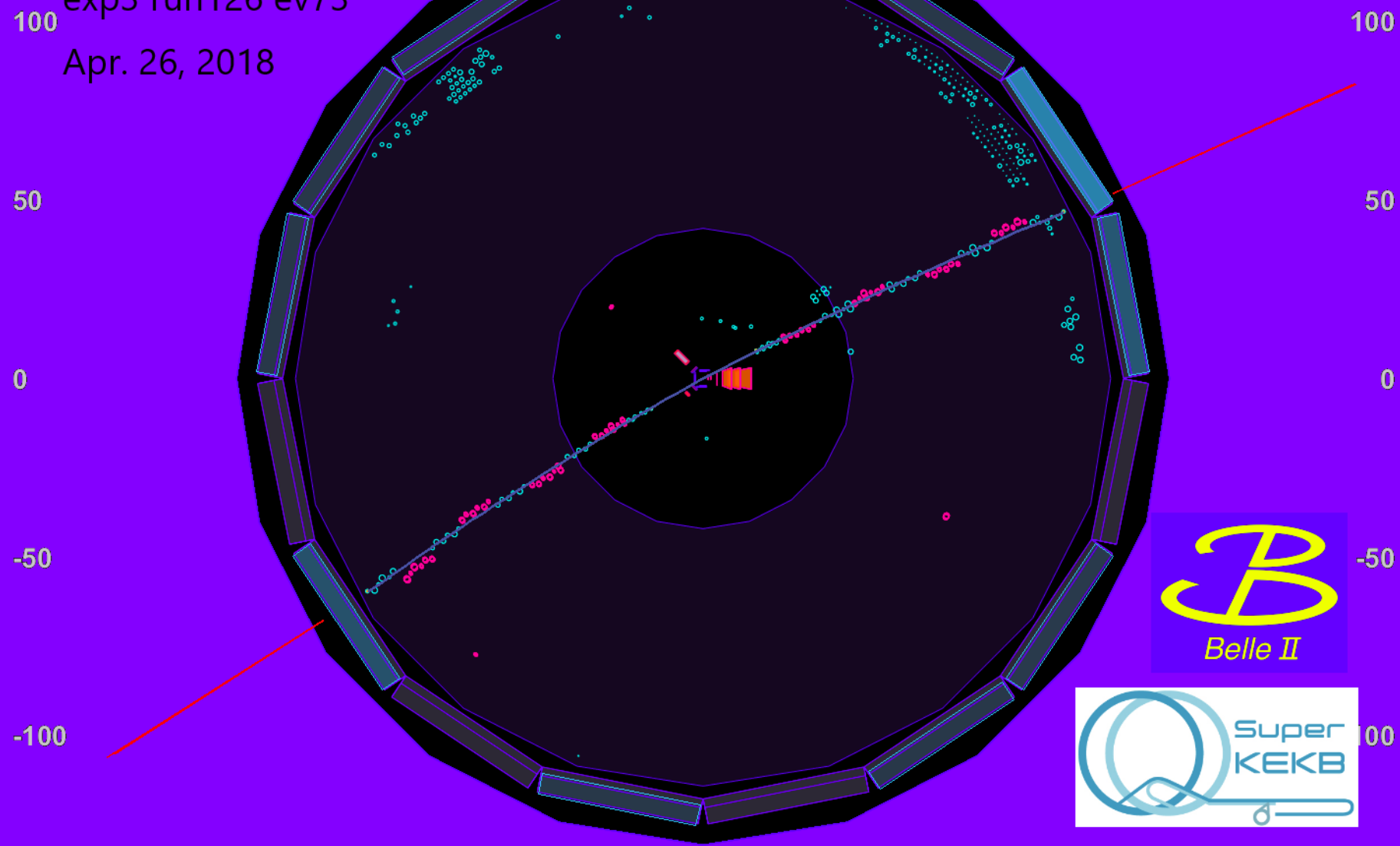

-150 -100 -50 0 50 100 150



First Preliminary Study with Data (5 pb^{-1})

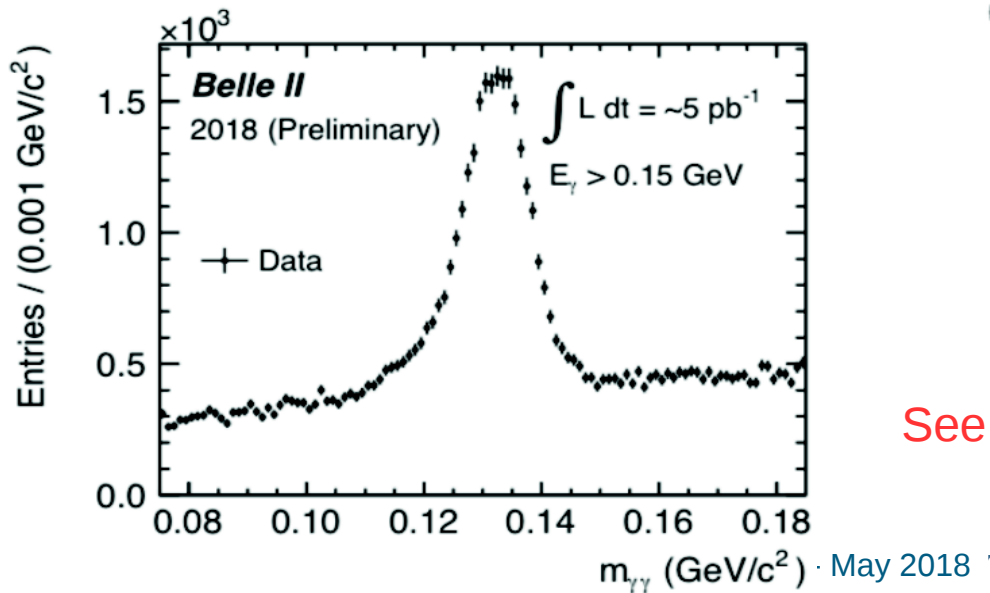
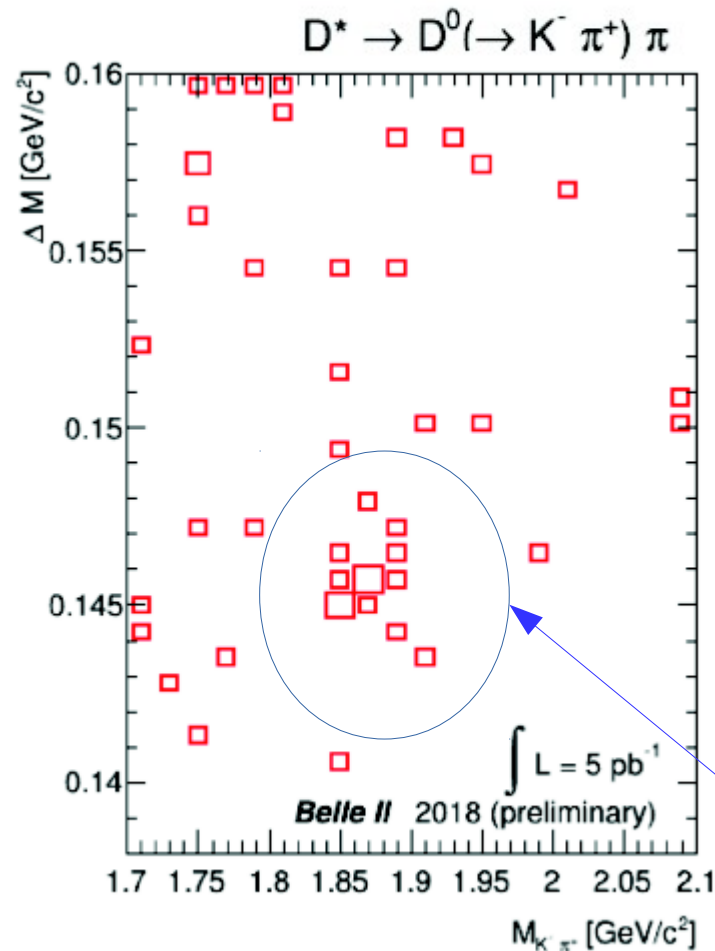
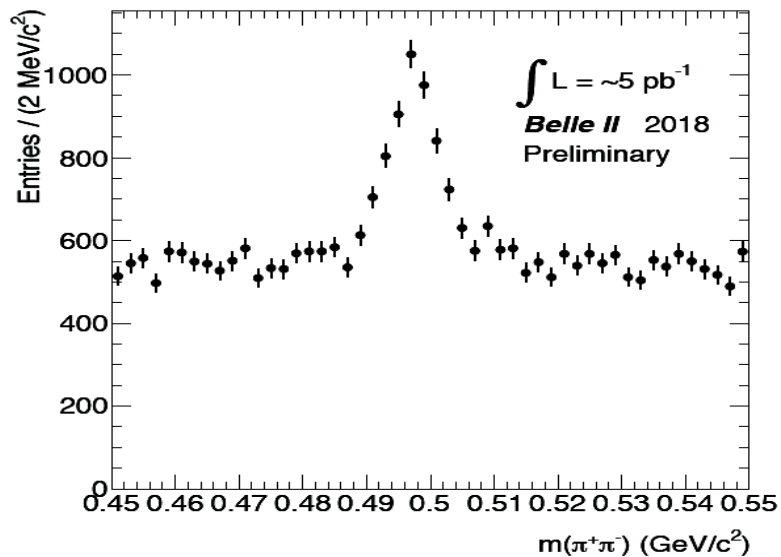

See talk of G. Casarosa, morning session

Summary



- Great achievements with Belle ($\sim 1 \text{ ab}^{-1}$) in spectroscopy, but still opportunities for unique physics with the new upgrade Belle II!
- In SuperKEKb e^+e^- collisions will reach unprecedented instantaneous luminosity: $8 \times 10^{35} \text{ cm}^{-2} \text{ s}^{-1}$
- Improved tracking and PID in Belle II
- **Phase-II in Belle II started**: experiment in good shape!
 - first cosmics seen in February, first collisions in **April 2018**
- Expected 50 ab^{-1} integrated luminosity at Belle II in 10 years
- With x50 more data than Belle, expected in Belle II great achievements in hadron spectroscopy:
 - **ISR analysis as unique case**
 - **favorite Bottomonium search through $\Upsilon(6S)$ compared to Belle**
 - **good slow pion reconstruction to search for $D^*D^{(*)}$ threshold exotic states**

***Thank you for your
kind attention!***

e.prencipe@fz-juelich.de

*“The greatest danger for most of us lies not in setting our aim too high and falling short;
but in setting our aim too low, and achieve our mark.” (Michelangelo, 1475 - 1564)*

Backup slides

Luminosity at the B Factories

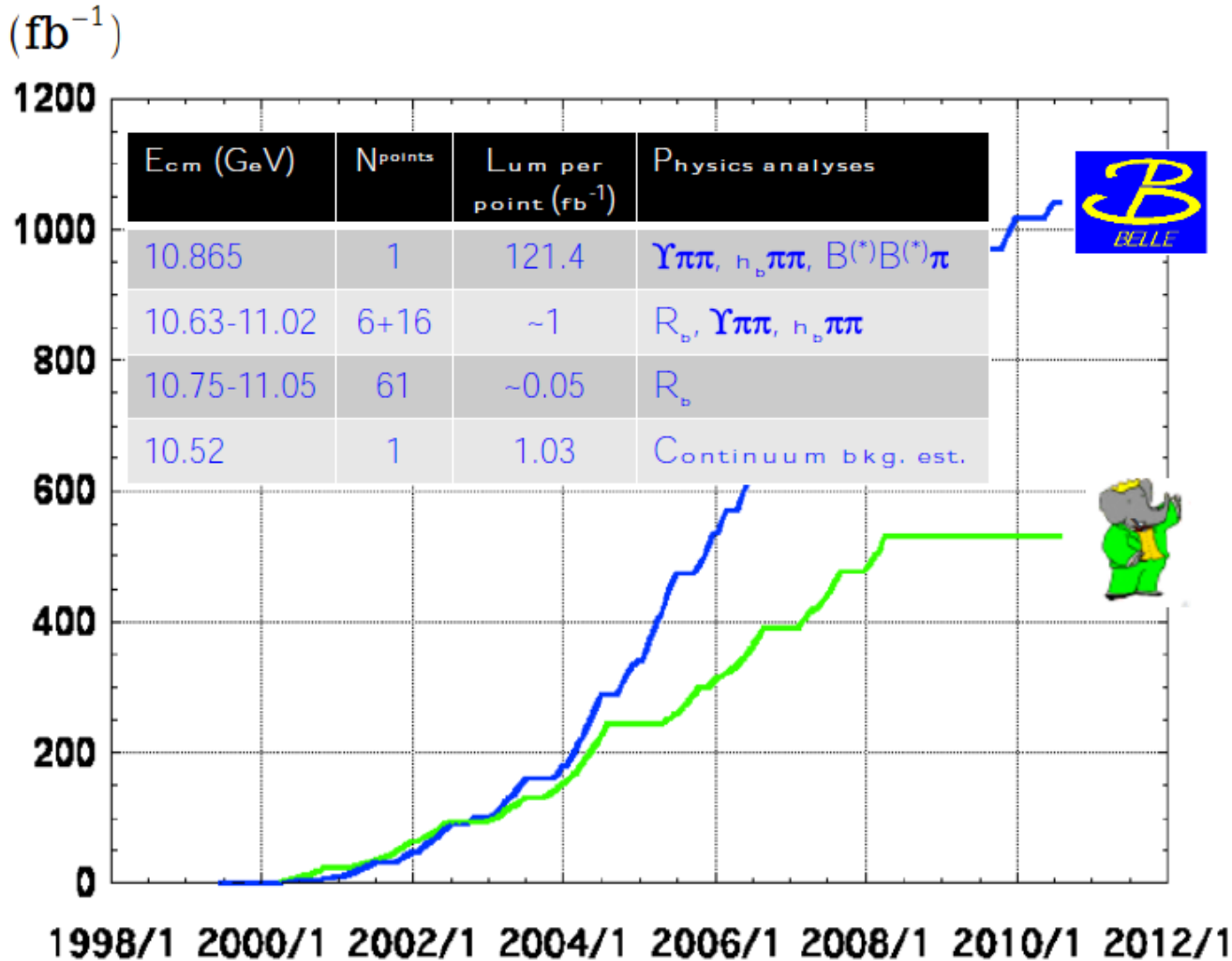

> 1 ab⁻¹

On resonance:

$Y(5S): 121 \text{ fb}^{-1}$

$Y(4S): 711 \text{ fb}^{-1}$

$Y(3S): 3 \text{ fb}^{-1}$

$Y(2S): 25 \text{ fb}^{-1}$

$Y(1S): 6 \text{ fb}^{-1}$

Off reson./scan:

~ 100 fb⁻¹

~ 550 fb⁻¹

On resonance:

$Y(4S): 433 \text{ fb}^{-1}$

$Y(3S): 30 \text{ fb}^{-1}$

$Y(2S): 14 \text{ fb}^{-1}$

Off resonance:

~ 54 fb⁻¹

Charmonium Production at B Factories

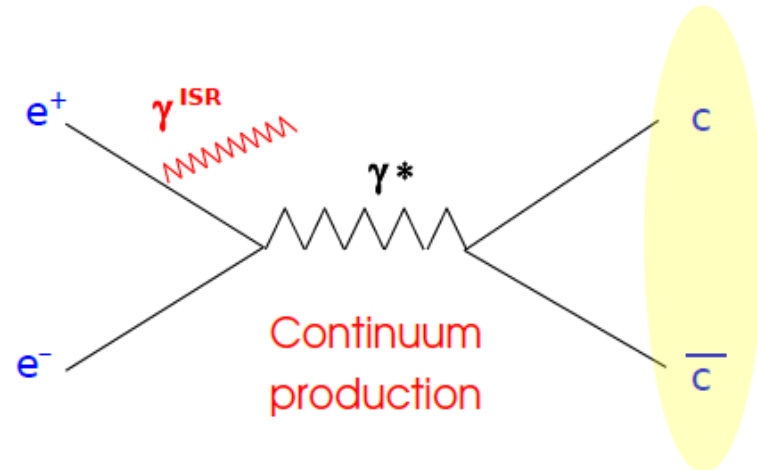
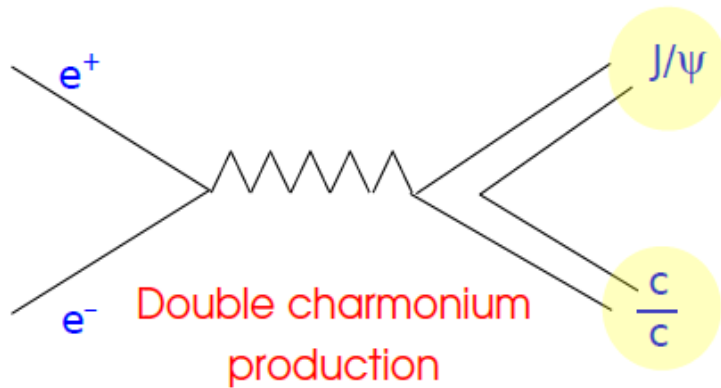
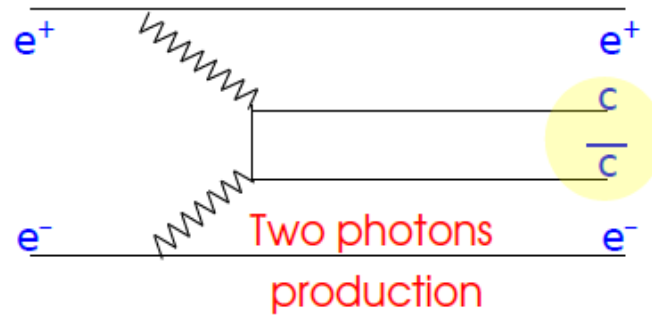
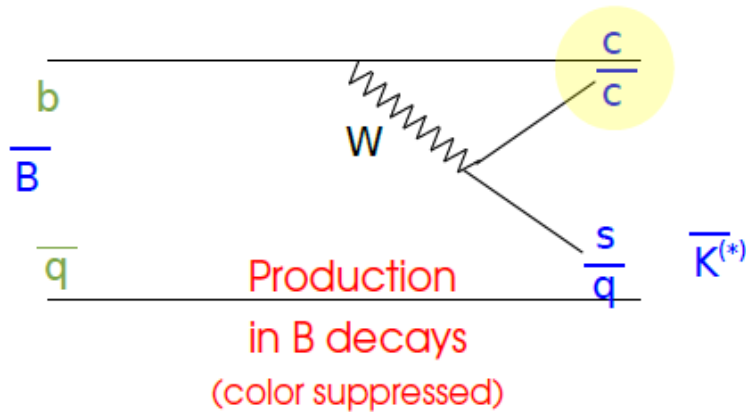

Main Achievements in Bottomonium at Belle

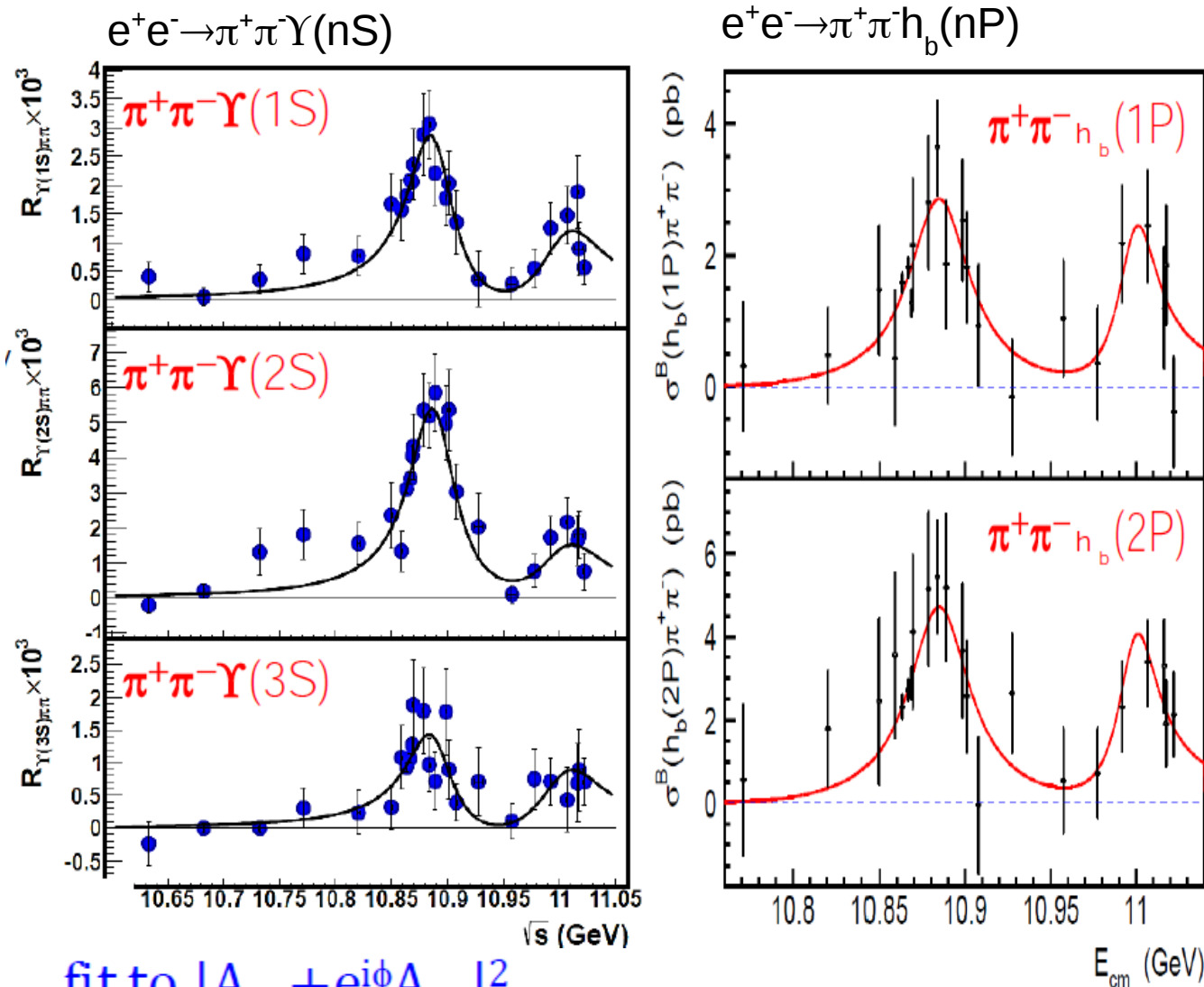

fit to $|A_{5S} + e^{i\phi}A_{6S}|^2$

PRD 93, 011101(R) (2016)

PRL117, 142001 (2016)

21- May 2018

Seite 39

Main Achievements in Bottomonium at Belle

Z_b in $\Upsilon(nS) \rightarrow \pi^+ \pi^- \Upsilon(nS)$

Parameter	$\Upsilon(1S)\pi^+\pi^-$	$\Upsilon(2S)\pi^+\pi^-$	$\Upsilon(3S)\pi^+\pi^-$
$f_{Z_b^\mp(10610)\pi^\pm}$, %	$4.8 \pm 1.2^{+1.5}_{-0.3}$	$18.1 \pm 3.1^{+4.2}_{-0.3}$	$30.0 \pm 6.3^{+5.4}_{-7.1}$
$Z_b(10610)$ mass, MeV/c^2	$10608.5 \pm 3.4^{+3.7}_{-1.4}$	$10608.1 \pm 1.2^{+1.5}_{-0.2}$	$10607.4 \pm 1.5^{+0.8}_{-0.2}$
$Z_b(10610)$ width, MeV/c^2	$18.5 \pm 5.3^{+6.1}_{-2.3}$	$20.8 \pm 2.5^{+0.3}_{-2.1}$	$18.7 \pm 3.4^{+2.5}_{-1.3}$
$f_{Z_b^\mp(10650)\pi^\pm}$, %	$0.87 \pm 0.32^{+0.16}_{-0.12}$	$4.05 \pm 1.2^{+0.95}_{-0.15}$	$13.3 \pm 3.6^{+2.6}_{-1.4}$
$Z_b(10650)$ mass, MeV/c^2	$10656.7 \pm 5.0^{+1.1}_{-3.1}$	$10650.7 \pm 1.5^{+0.5}_{-0.2}$	$10651.2 \pm 1.0^{+0.4}_{-0.3}$
$Z_b(10650)$ width, MeV/c^2	$12.1^{+11.3+2.7}_{-4.8-0.6}$	$14.2 \pm 3.7^{+0.9}_{-0.4}$	$9.3 \pm 2.2^{+0.3}_{-0.5}$
ϕ_Z , degrees	$67 \pm 36^{+24}_{-52}$	$-10 \pm 13^{+34}_{-12}$	$-5 \pm 22^{+19}_{-33}$
$c_{Z_b(10650)}/c_{Z_b(10610)}$	$0.40 \pm 0.12^{+0.05}_{-0.11}$	$0.53 \pm 0.07^{+0.32}_{-0.11}$	$0.69 \pm 0.09^{+0.18}_{-0.07}$
$f_{\Upsilon(nS)f_2(1270)}$, %	$14.6 \pm 1.5^{+6.3}_{-0.7}$	$4.09 \pm 1.0^{+0.33}_{-1.0}$	—
$f_{\Upsilon(nS)(\pi^+\pi^-)_S}$, %	$86.5 \pm 3.2^{+3.3}_{-4.9}$	$101.0 \pm 4.2^{+6.5}_{-3.5}$	$44.0 \pm 6.2^{+1.8}_{-4.3}$
$f_{\Upsilon(nS)f_0(980)}$, %	$6.9 \pm 1.6^{+0.8}_{-2.8}$	—	—

$\sigma_{Z_b^\pm(10610)\pi^\mp} \times \mathcal{B}_{\Upsilon(1S)\pi^\mp} = 109 \pm 27^{+35}_{-10}$ fb	$\sigma_{Z_b^\pm(10650)\pi^\mp} \times \mathcal{B}_{\Upsilon(1S)\pi^\mp} = 20 \pm 7^{+4}_{-3}$ fb
$\sigma_{Z_b^\pm(10610)\pi^\mp} \times \mathcal{B}_{\Upsilon(2S)\pi^\mp} = 737 \pm 126^{+188}_{-85}$ fb	$\sigma_{Z_b^\pm(10650)\pi^\mp} \times \mathcal{B}_{\Upsilon(2S)\pi^\mp} = 165 \pm 49^{+43}_{-20}$ fb
$\sigma_{Z_b^\pm(10610)\pi^\mp} \times \mathcal{B}_{\Upsilon(3S)\pi^\mp} = 438 \pm 92^{+92}_{-114}$ fb	$\sigma_{Z_b^\pm(10650)\pi^\mp} \times \mathcal{B}_{\Upsilon(3S)\pi^\mp} = 194 \pm 53^{+43}_{-25}$ fb

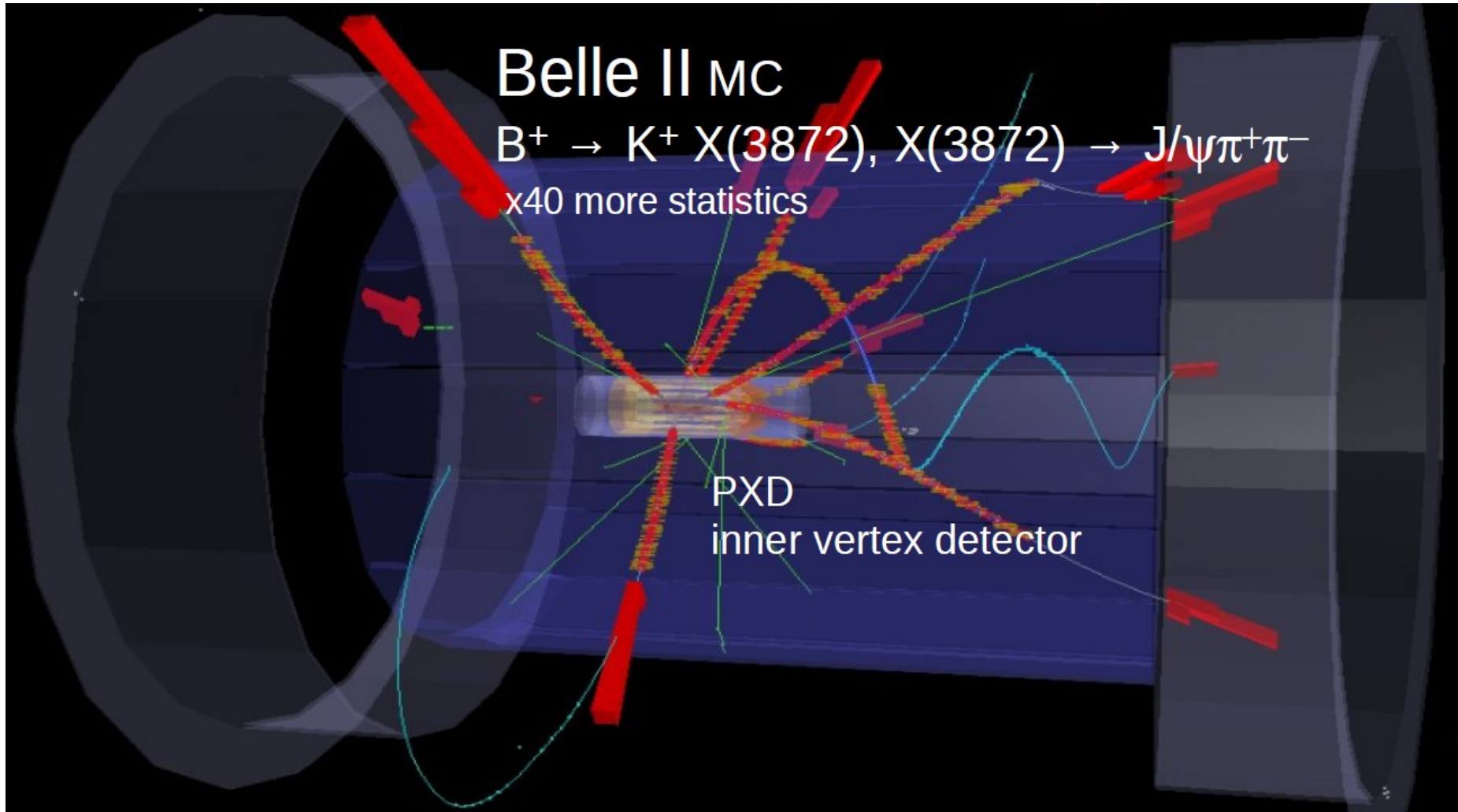

Nano-Beam Scheme

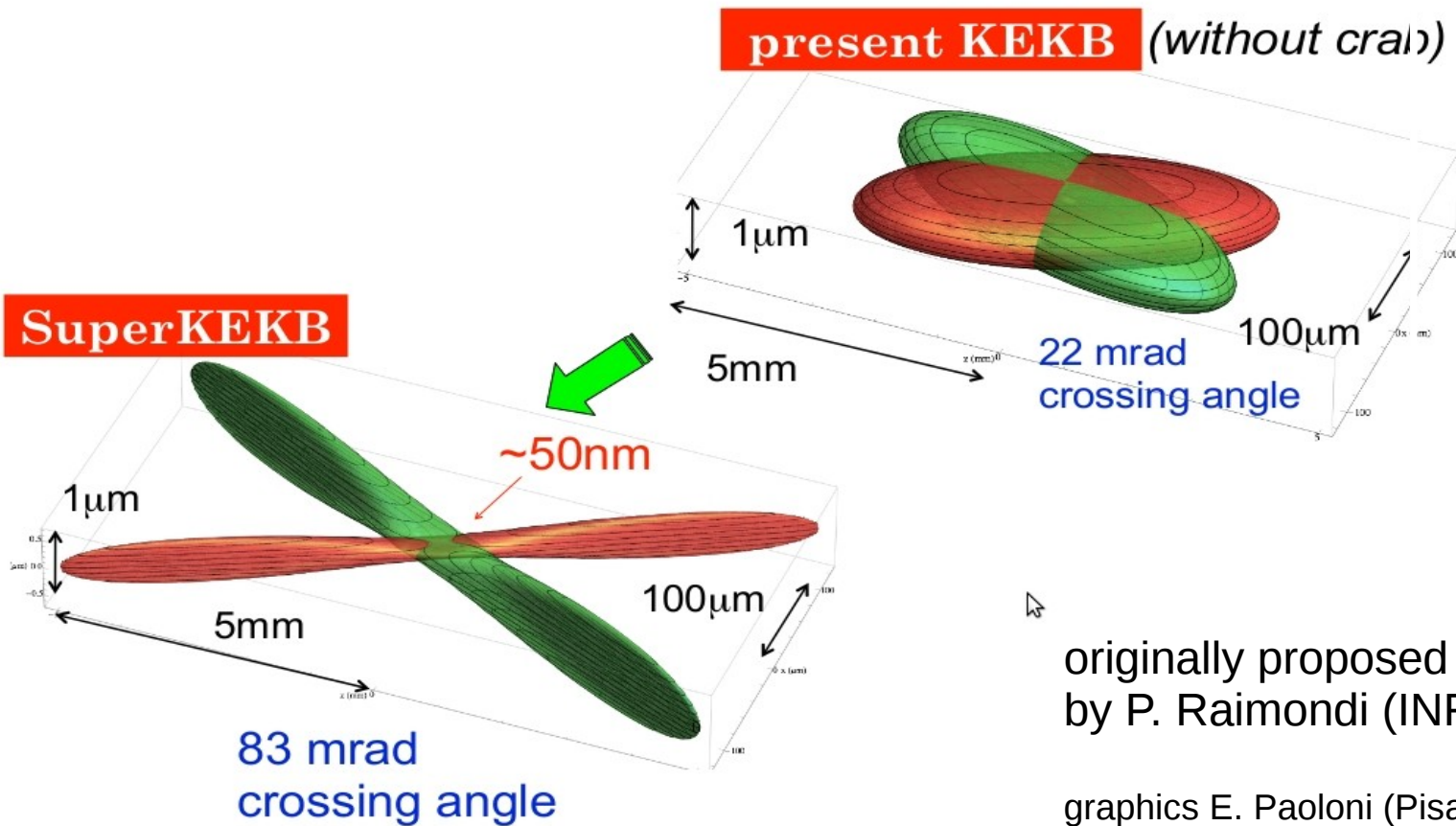

↳

originally proposed for SuperB by P. Raimondi (INFN)

graphics E. Paoloni (Pisa)

X(3872): ACHIEVEMENTS AND INTERPRETATION AT BELLE

~150 events in 10 years

Belle. Phys Rev D84(2011)052004

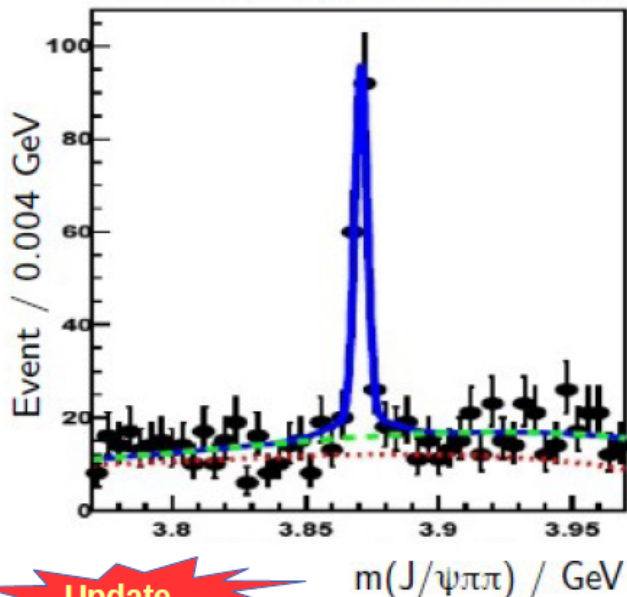

$$M_{X(3872)} = (3871.85 \pm 0.27(\text{stat}) \pm 0.19(\text{syst})) \text{ MeV}$$

$$B(B^+ \rightarrow K^+ X(3872)) \times B(X(3872) \rightarrow \pi^+ \pi^- J/\psi) = (8.63 \pm 0.82(\text{stat}) \pm 0.52(\text{syst})) \times 10^{-6}$$

$$B(B^0 \rightarrow K^0 X(3872)) / B(B^+ \rightarrow K^+ X(3872)) = 0.50 \pm 0.14(\text{stat}) \pm 0.04(\text{syst})$$

$$\Delta M_{X[B^0-B^+]} = (-0.71 \pm 0.96(\text{stat}) \pm 0.19(\text{syst})) \text{ MeV.}$$

- X(3872) observed in different decay modes, and different production mechanisms
- At $D\bar{D}^*$ threshold $E_B = 160 \pm 330 \text{ keV}$, but no threshold effect
- $\Gamma \leq 1.2 \text{ MeV}$ → too narrow! Bugg, JPHG35 (2008) 075005
- The $D\bar{D}^*$ decay of the X(3872) is dominant ~ x10 than other X(3872) decay modes → a **molecule?**
- Isospin-violating decay: $B(X(3872) \rightarrow J/\psi \rho)$, $\sim 10^2$ too large

X(3872): ACHIEVEMENTS AND INTERPRETATION AT BELLE

- Correlation function from MC
 $\Gamma(\text{output}) = f(\Gamma(\text{input}))$
- 3-dim fits validated with ψ' width
 $\Gamma_{\psi'} = 0.52 \pm 0.11$ MeV
(PDG: 0.304 ± 0.009 MeV)
→ bias 0.23 ± 0.11 MeV
- procedure for upper limit:
width in 3-dim fit fixed
 n_{signal} and n_{BG} floating
→ calculate likelihood
- $\Gamma_{X(3872)} < 0.95$ MeV + bias

PRD 84 (2011) 052004

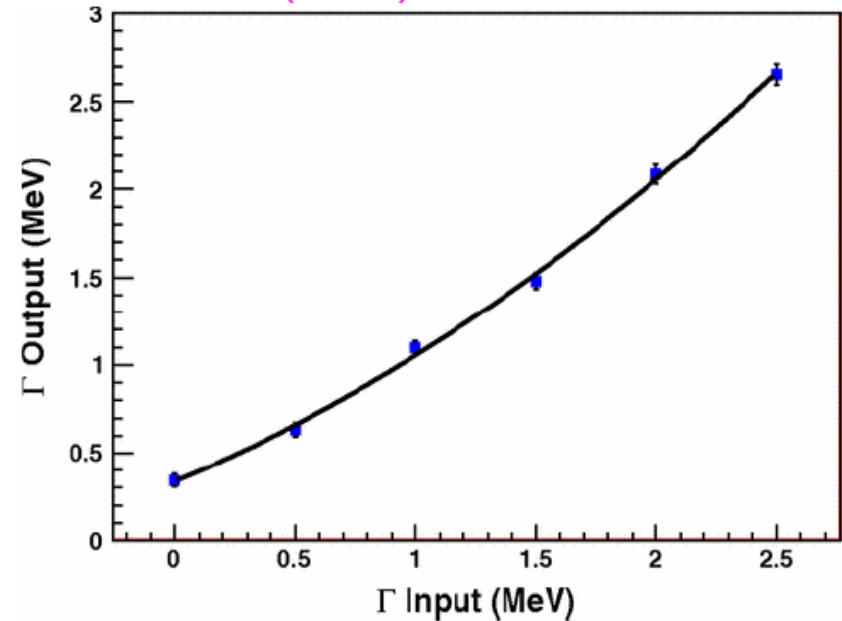

Reference channel: $B \rightarrow \psi(2s)\pi^+\pi^-$

X(3872): ACHIEVEMENTS AND INTERPRETATION AT BELLE

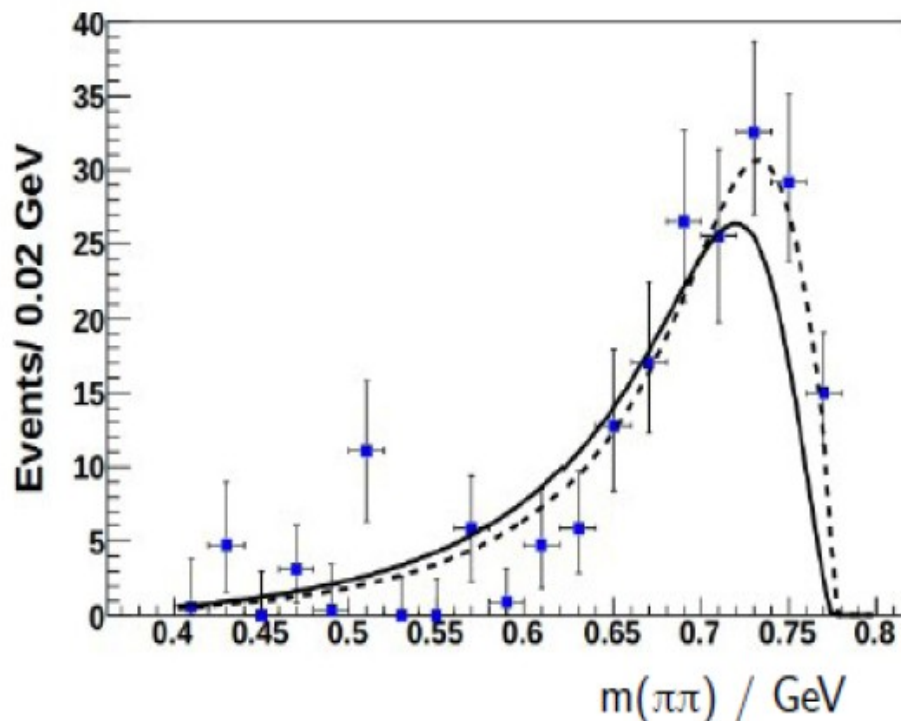

- Isospin-violating decay:
 $B(X(3872) \rightarrow J/\psi \rho)$, factor 10^2 too large
 $J^{PC} = 1^{++}$, predicted nearby χ_{c1}
Barnes et al, PRD72 (2005) 054026
- Mass ≥ 50 MeV higher
- Width ≥ 100 larger

What can be done better to disclose the nature of the X(3872)?

X(3872)

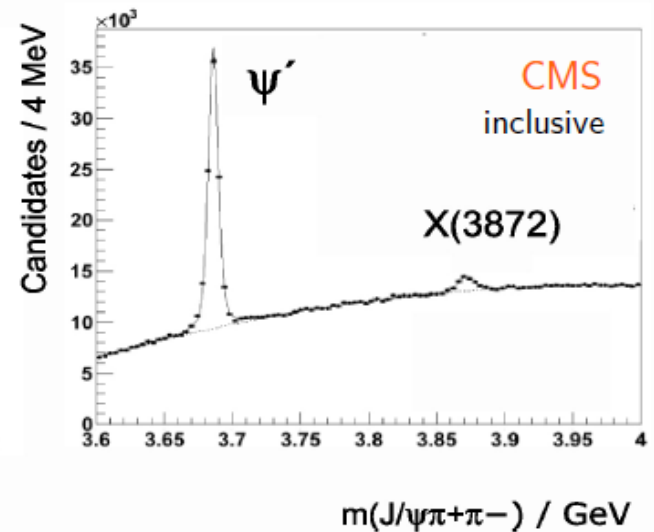
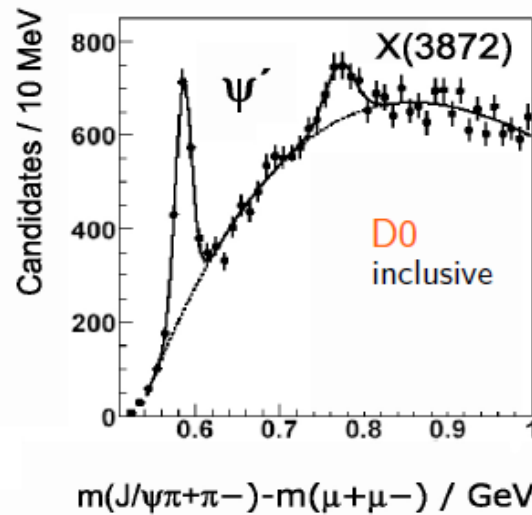
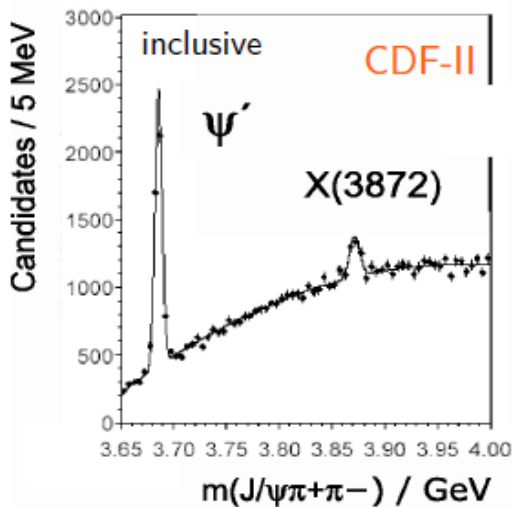
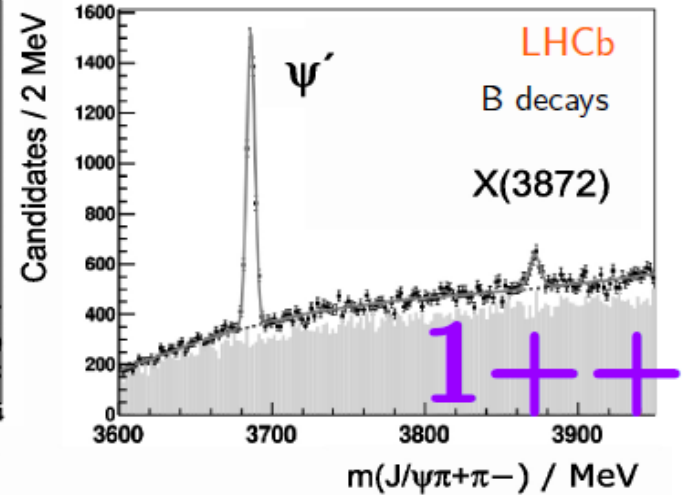
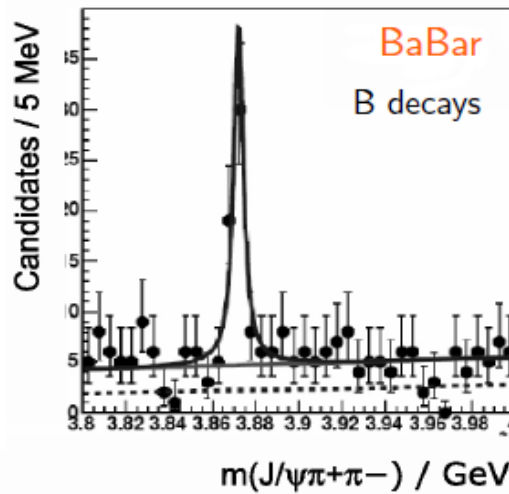
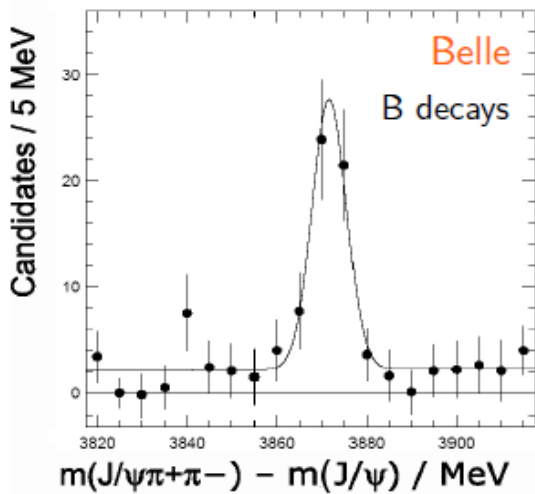

Photoproduction of X(3872)

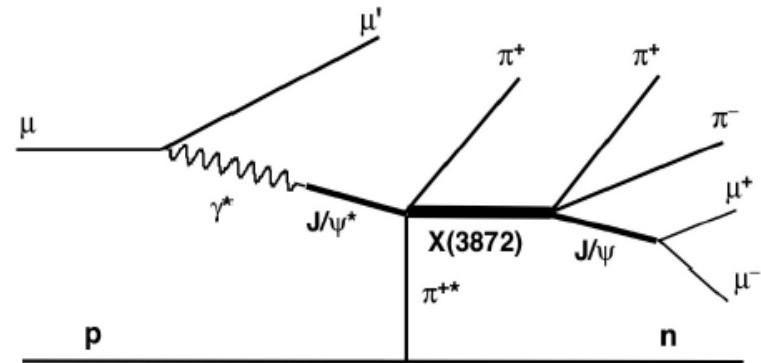

Muon data 2003-2010

$$N_{\psi(2S)} = 16.1 \pm 5.2$$

$$N_{X(3872)} = 13.9 \pm 4.9$$

$$\sigma_M = 20.6 \pm 6.1 \text{ MeV}$$

COMPASS, arXiv:1707.01796 [hep-ex]

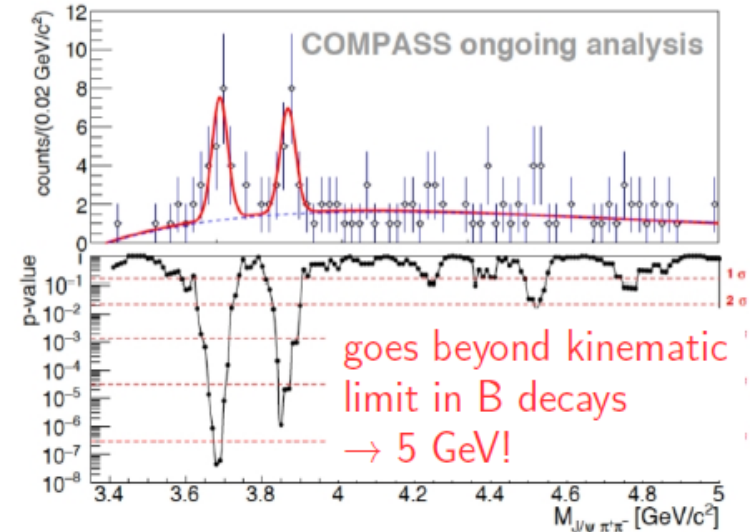

Is the X(3872) exotic ?

TETRAQUARK



$$[qQ]_8[\bar{q}\bar{Q}]_8$$

Diquarks
are colored

Maiani, Riquer, Piccinini, Polosa, Burns;
Ebert, Faustov, Galkin; Chiu, Hsieh;
Ali, Hambrock, Wang

THRESHOLD CUSP

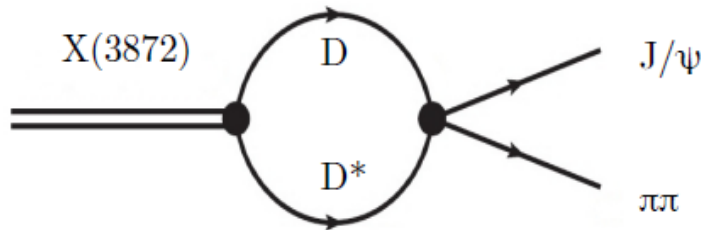

Bugg; Swanson

MOLECULE

Intriguing Analogon

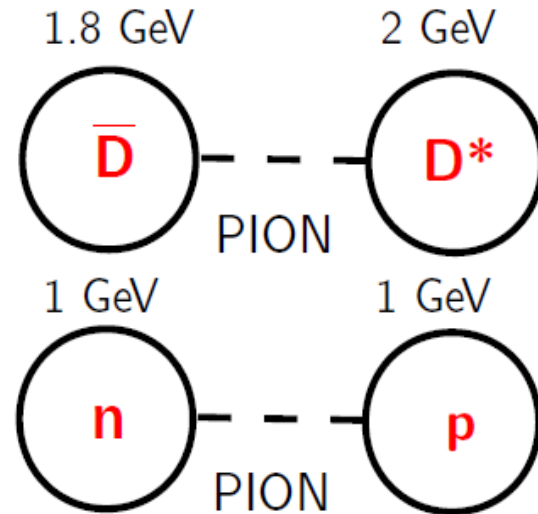

Tornqvist; Swanson; Braaten, Kusunoki,
Wong; Voloshin; Close, Page
Guo, Hanhart, Meissner

courtesy of J.S. Lange, HIRSCHEGG2018

Y(4260)

- Initial state radiation events

$$e^+e^- \rightarrow \gamma_{ISR} \underbrace{J/\psi\pi^+\pi^-}_{\text{resonant state?}}$$

- Quantum numbers

$$JPC=1^{--}$$

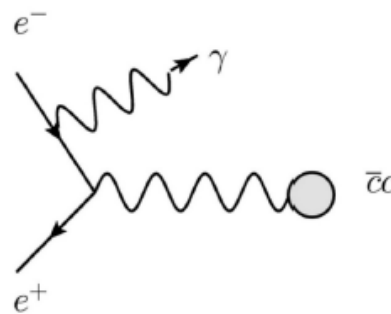

(based upon production r

- decay to e^+e^- not seen (although 1^{--})
- decay to $D^{(*)}D^{(*)}$ not seen (although phasespace huge)
- recent hot topic: lineshape distortion at $DD_1(2460)$ threshold ?

BESIII, Phys. Rev. Lett. 118 (9) (2017) 092001

BESIII, PRL110(2013)252001

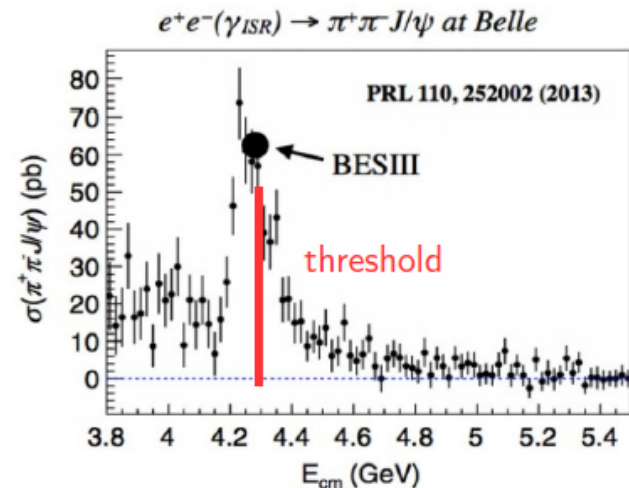
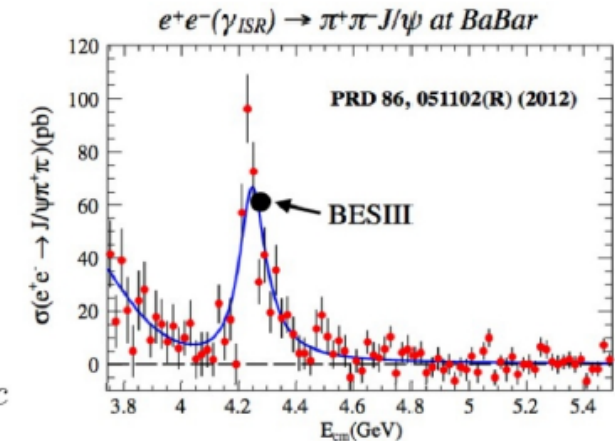

Y(4260) parameters

	BABAR	CLEO-c	Belle	Belle	BABAR	BABAR	BESIII
\mathcal{L}	211 fb ⁻¹	13.3 fb ⁻¹	553 fb ⁻¹	548 fb ⁻¹	454 fb ⁻¹	454 fb ⁻¹	9 fb ⁻¹
N	125±23	14.1 ^{+5.2} _{-4.2}	165±24	324±21	344±39	–	3853±68
\mathcal{S}	≈8σ	≈4.9σ	≥7σ	≥15σ	–	–	7.6σ
m	4259±8 ⁺² ₋₆	4283 ⁺¹⁷ ₋₁₆ ±4	4295±10 ⁺¹⁰ ₋₃	4247±12 ⁺¹⁷ ₋₃₂	4252±6 ⁺² ₋₃	4244±5±4	4222.0±3.1±1.4
Γ	88±23 ⁺⁶ ₋₄	70 ⁺⁴⁰ ₋₂₅	133±26 ⁺¹³ ₋₆	108±19±10	105±18 ⁺⁴ ₋₆	114 ⁺¹⁶ ₋₁₅ ±7	44.1±4.3±2.0

BaBar, Phys. Rev. Lett. 95(2005)142001
 CLEO-c, Phys. Rev. D74(2006)091104
 Belle, arXiv:hep-ex/0612006
 Belle, Phys. Rev. Lett. 99(2007)182004
 BaBar, arXiv:08081543[hep-ex]
 BaBar, Phys. Rev. D86(2012)051102
 BESIII, Phys. Rev. Lett. 118(2017)092001



Recent hot topic:
 mass in direct e⁺e⁻
 seems lower than in ISR

Is the $Y(4260)$ exotic ?

TETRAQUARK

higher excitation ?

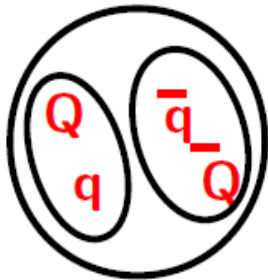

Maiani, Riquer, Piccinini, Polosa, Burns

HADRO-CHARMONIUM [J/ψ $f_0(980)$]

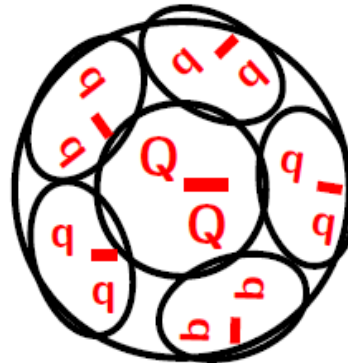

Voloshin, Li
(Guo, Hanhart, Meissner)

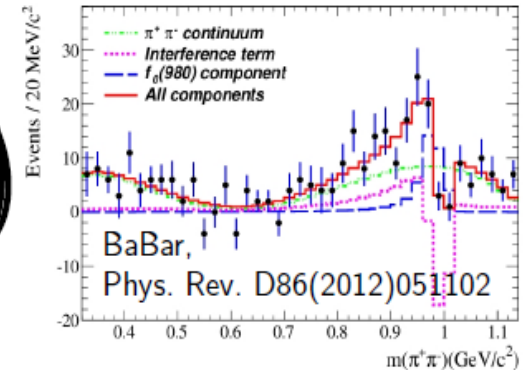

MOLECULE

heavier mesons ($\bar{D}D_1(2460)$) ?

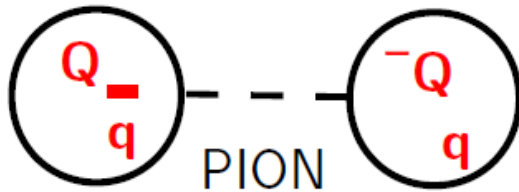

[Swanson, Rosner, Close
Guo, Hanhart, Meissner]

HYBRID

$[Q\bar{Q}]_8g$

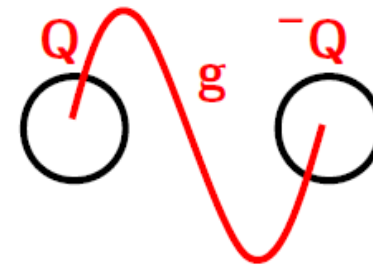

Zhu; Kou, Pene; Close, Page;
Lattice QCD, Bernard et al.; Mei, Luo
courtesy of J.S. Lange, HIRSCHEGG2018

Y STATES

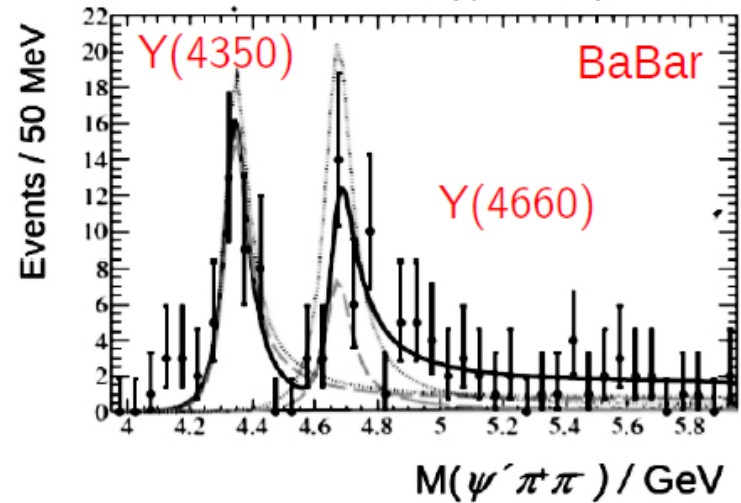
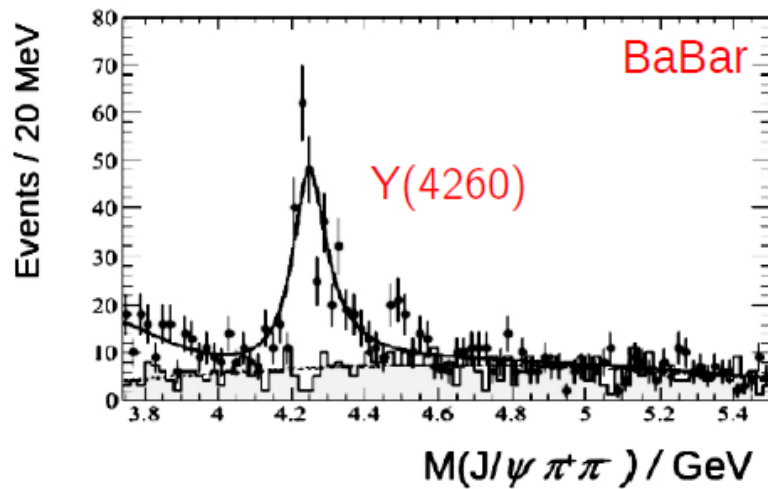
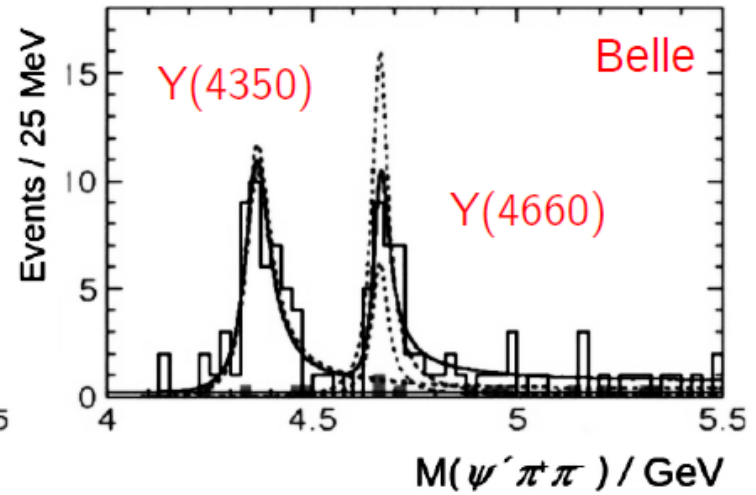
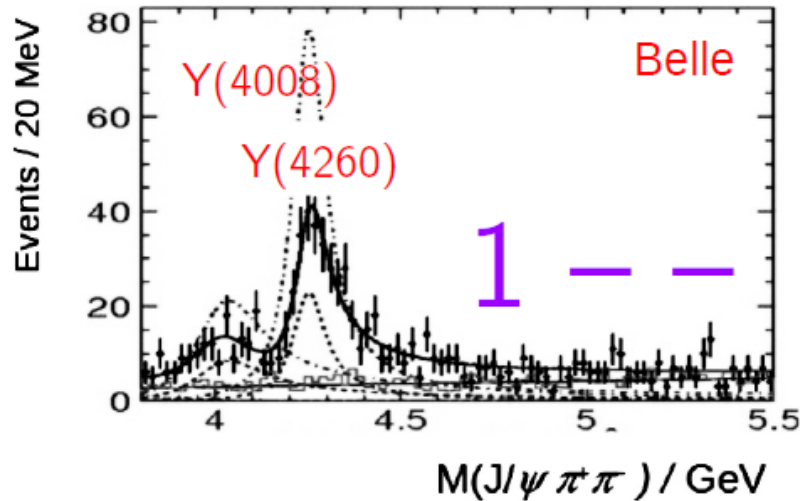

Cornell-Potential

Eichten, Gottfried, et al. PRD 17(1978)3090
 Barnes, Godfrey, Swanson, PRD 72(2005)054026

- Coulomb-Potential
 + Confinement-Term

$$V(r) = -\frac{4\alpha_s}{3r} + \boxed{kr}$$

spin-spin $+\frac{32\pi\alpha_s}{9m_c^2}\delta_r\vec{S}_c\vec{S}_{\bar{c}}$

spin-orbit $+\frac{1}{m_c^2}\left(\frac{2\alpha_s}{r^3} - \frac{k}{2r}\right)\vec{L}\vec{S}$

tensor $+\frac{1}{m_c^2}\frac{4\alpha_s}{r^3}\left(\frac{3\vec{S}_c\vec{r}\cdot\vec{S}_{\bar{c}}\vec{r}}{r^2} - \vec{S}_c\vec{S}_{\bar{c}}\right)$

- solve Schrödinger equation
 (quark mass heavy → on-relativistic)
 → states

$$\Psi(r, \theta, \phi) = R_{nl}(r)Y_{lm}(\theta, \phi)$$

$$\left[-\frac{1}{m_q}\left(\frac{\partial^2}{\partial r^2} + \frac{2}{r}\frac{\partial}{\partial r} + \frac{l(l+1)}{m_q r^2}\right) + V(r)\right]R_{nl}(r) = E_{nl}R_{nl}(r)$$

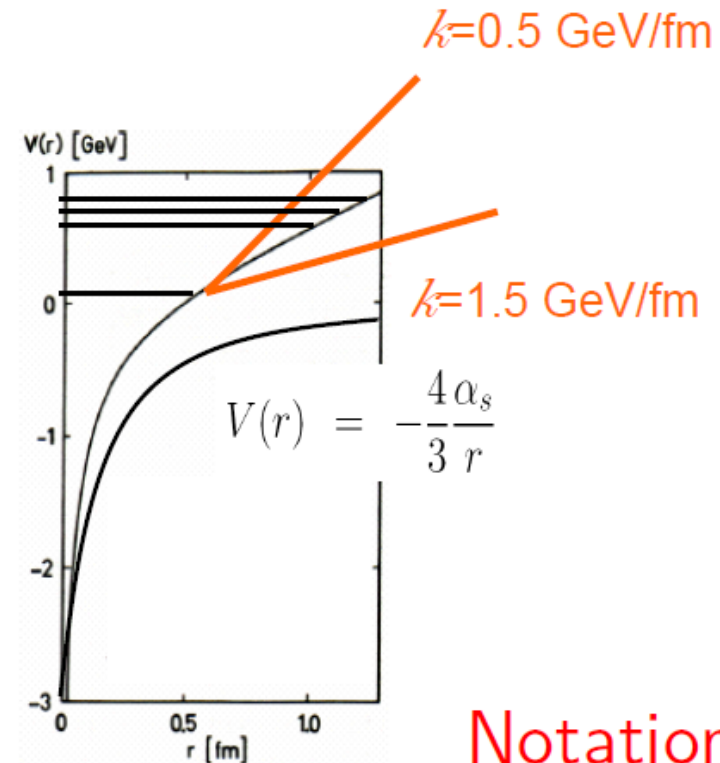

Notation
 $n^{2S+1}L_J$
 JPC

Cornell potential: Wronski-Determinant must be zero at turning point

$$r_{\text{turning point}} = \frac{E - 2m}{2\sigma} + \sqrt{\frac{4m^2 - 4mE + E^2}{4\sigma^2} + \frac{4\alpha_s}{3\sigma}}$$

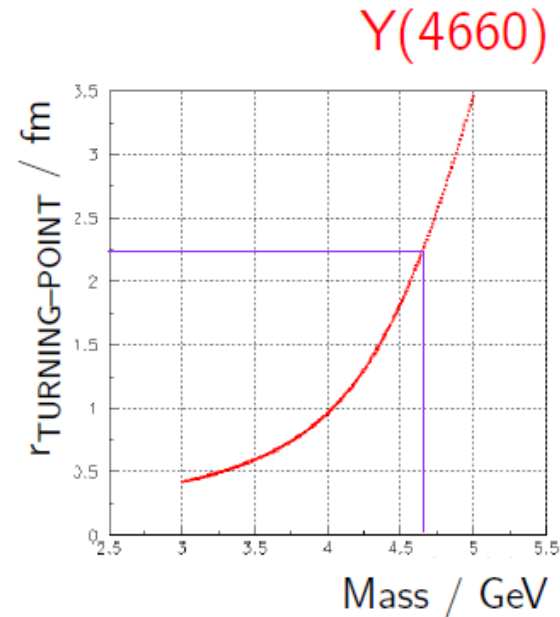
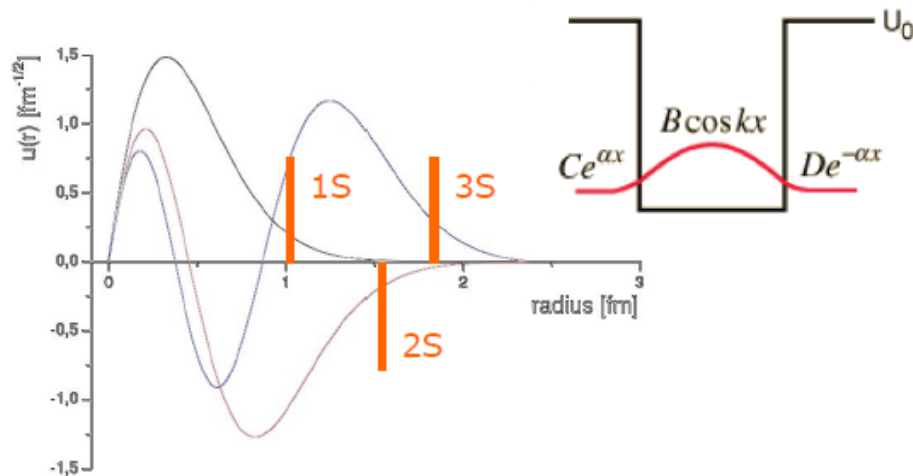

- $m=4.660$ GeV \rightarrow turning point of wave function is **2.2 fm!**
- large fraction of wave function in string breaking regime $r>1.4$ fm

courtesy of J.S. Lange, HIRSCHEGG2018

Charmonium vs. Positronium

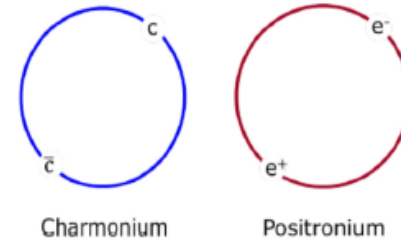

Decays to light quarks suppressed
 → narrow widths

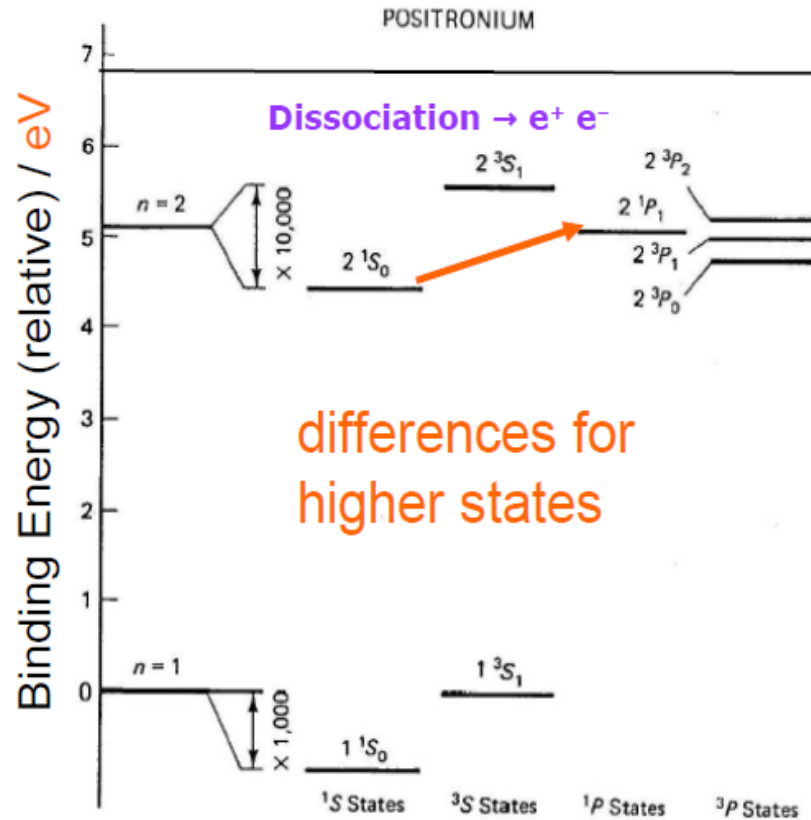
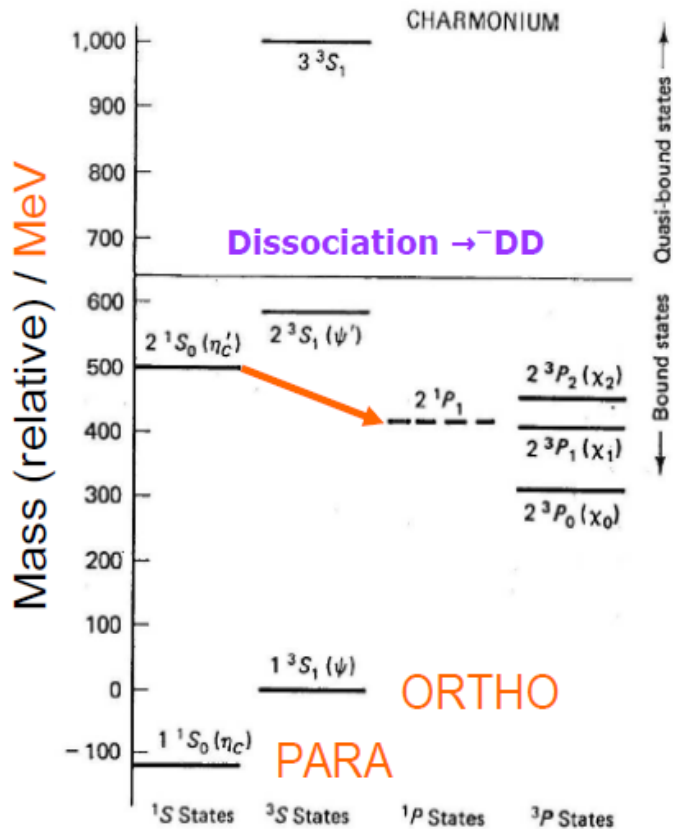

courtesy of J.S. Lange, HIRSCHEGG2018



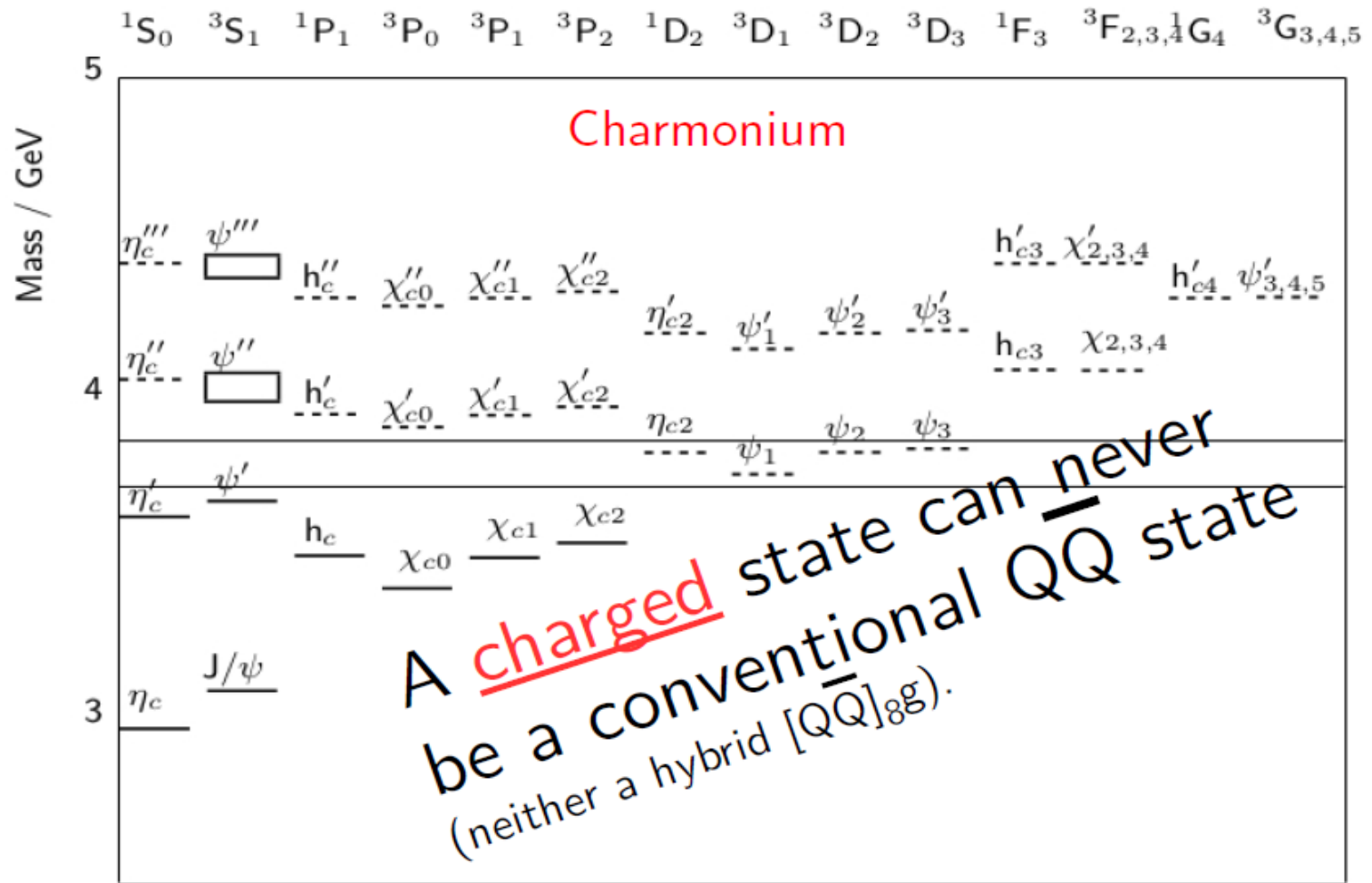

JPC

0^{-+} 1^{-} 1^{+-} 0^{++} 1^{++} 2^{++} 2^{-+} 1^{-} 2^{-} 3^{-} 3^{+-} $2,3,4^{++}$ $3,4,5^{-}$

Barnes, Godfrey, Swanson, Phys. Rev. D72(2005)054026

4^{-+}

Z STATES AT BESIII

$\bar{D}D^*$ threshold

$D^*\bar{D}^*$ threshold

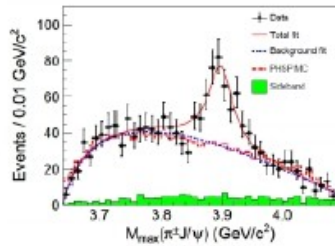

$e^+e^- \rightarrow \pi^+ \pi^- J/\Psi$

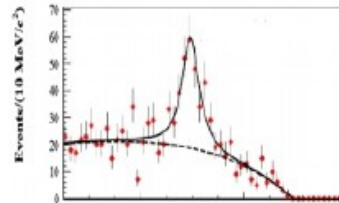

$e^+e^- \rightarrow \pi^0 \pi^0 J/\Psi$

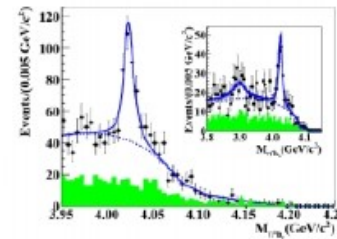

$e^+e^- \rightarrow \pi^+ \pi^- h_c$

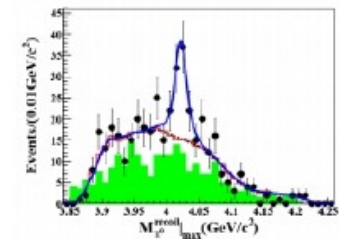

$e^+e^- \rightarrow \pi^0 \pi^0 h_c$

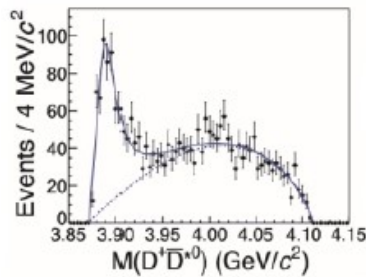

$e^+e^- \rightarrow \pi^+ (D\bar{D}^*)^-$

charged

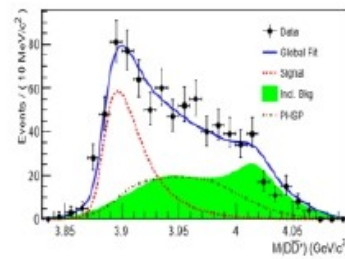

$e^+e^- \rightarrow \pi^0 (D\bar{D}^*)^0$

neutral

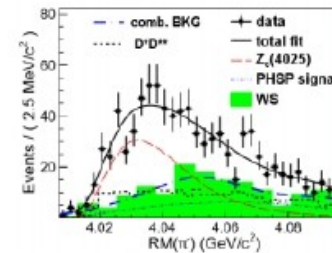

$e^+e^- \rightarrow \pi^+ (D^*\bar{D}^*)^-$

charged

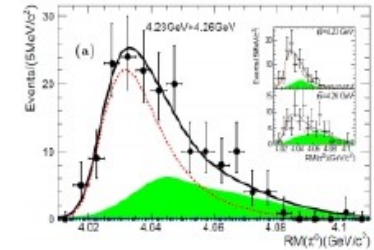

$e^+e^- \rightarrow \pi^0 (D^*\bar{D}^*)^0$

neutral

Recent hot topic: neutral partners \rightarrow isospin triplets
All of them $1+$, wherever tested.

Z states and „confinement“ ?

All measured Z_c^+ masses are above $D^{(*)}\bar{D}^{(*)}$ thresholds

State	m (MeV)	Threshold	Δm (MeV)
$Z_c(3900)$	$3899.0 \pm 3.6 \pm 4.9$	$D^+\bar{D}^{0*}$	+22.4
$Z_c(3900)$	$3899.0 \pm 3.6 \pm 4.9$	$D^0\bar{D}^{+*}$	+23.9
$Z_c(3900)$	$3894.5 \pm 6.6 \pm 4.5$	$D^+\bar{D}^{0*}$	+17.9
$Z_c(3900)$	$3894.5 \pm 6.6 \pm 4.5$	$D^0\bar{D}^{+*}$	+19.4
$Z_c(3900)$	$3885 \pm 5 \pm 1$	$D^+\bar{D}^{0*}$	+8.4
$Z_c(3900)$	$3885 \pm 5 \pm 1$ MeV	$D^0\bar{D}^{+*}$	+9.9
$Z_c(3885)$	$3883.9 \pm 1.5 \pm 4.2$	$D^+\bar{D}^{0*}$	+7.4
$Z_c(3885)$	$3883.9 \pm 1.5 \pm 4.2$	$D^0\bar{D}^{+*}$	+8.8
$Z_c(4020)$	$4022.9 \pm 0.8 \pm 2.7$	$D^{0*}\bar{D}^{\pm*}$	+5.6
$Z_c(4025)$	$4026.3 \pm 2.6 \pm 3.7$	$D^{0*}\bar{D}^{\pm*}$	+9.0
$Z_c(4032)^+$	$\simeq 4032.1 \pm 2.4$	$D^{0*}\bar{D}^{\pm*}$	+15.0

	possible?
threshold CUSP	no (must be @ threshold)
tetraquark	yes (spin–spin forces)
molecules	no, if bound state (pole below threshold, $E_B > 0$)

A MC study of slow pion tracking efficiency, and pions from K_S^0 in $B^0 \rightarrow \Phi K_S^0$
(fake rate of 50%). Master Thesis (Belle II) – L. Koch - 2016

